



PRODUCT CATALOG

FITNESS & GYM

www.hms-fitness.pl



Marka HMS zrodziła się z połączenia pasji, przyjaźni oraz fascynacji sportem. Od samego początku poszukujemy innowacyjnych rozwiązań ułatwiających i propagujących aktywność fizyczną. Doświadczenie, najwyższa jakość użytych materiałów, wzornictwo wpisujące się w najnowsze trendy oraz dbałość o perfekcyjne wykonanie, to główne cechy charakteryzujące nasze produkty.

Na przestrzeni lat marka HMS zdobyła uznanie wielu zadowolonych klientów na całym świecie. Nasza oferta, obejmująca kilkaset produktów z grupy fitness i sportów siłowych stale wzbogaca się o nowe urządzenia. Wielokrotnie prezentowaliśmy ją na „ISPO” w Monachium, „FIBO” w Kolonii, „SPORT LIFE” w Brnie, „FIWE” w Warszawie czy „FIT EXPO” Poznań oraz innych wystawach branżowych. Dziś logo HMS jest doskonale rozpoznawalne na europejskim rynku produktów fitness.

Szczególnie miejsce w naszej ofercie zajmuje ekskluzywna seria HMS Premium. Wprowadziliśmy ją do oferty z myślą o najbardziej wymagających użytkowników. Jej cechą charakterystyczną jest wykorzystanie wysokiej jakości materiałów, gwarantujących długą żywotność. W połączeniu z najlepszymi standardami produkcji oraz oryginalnym wzornictwem, seria HMS Premium jest gwarantem niepowtarzalnych wrażeń i satysfakcji z treningu. Zapraszamy do zapoznania się z naszą propozycją na sezon 2018/2019. Mamy nadzieję, że stanie się ona dla Państwa źródłem nowych możliwości i inspiracją do dalszej współpracy z marką HMS.

HMS brand was born from a combination of passion, friendship and fascination with the sport. From the beginning, we are looking for innovative solutions to facilitate and promote physical activity. Experience, highest quality of materials, the latest trends design and attention to perfect performance, are the main characteristics of our products.

Over the years, the brand HMS has won the recognition of many satisfied customers worldwide. Our offer, which includes hundreds of products from the group of fitness and strength sports is constantly enriched with new equipment. Many times we presented it to the „ISPO” in Munich, „FIBO” in Cologne, „SPORT LIFE” in Brno, „FIWE” in Warsaw, „FIT EXPO” in Poznan. Today logo HMS is well recognized in the European market for fitness products.

A special place in our offer is exclusive series HMS Premium. We introduced her to the offer for the most demanding users. Its characteristic feature is the use of high quality materials, guaranteeing a long service life. In conjunction with the best standards of production and original design, the series HMS Premium is a guarantee of unique experience and satisfaction with the training.

We invite you to familiarize yourself with our proposal for the season 2018/2019. We hope that it will become for you a source of new opportunities and inspiration for further cooperation with the brand HMS.

Značka HMS vznikla spojením vášně, přátelství a fascinace sportem. Od samého začátku hledáme inovativní řešení za účelem usnadnění a propagace fyzické aktivity. Zkušenost, nejvyšší jakost použitých materiálů, design odpovídající nejnovějším trendům a snaha o perfektní provedení, jsou hlavními vlastnostmi charakterizujícími naše produkty.

V průběhu let si značka HMS získala uznání spousty spokojených klientů po celém světě. Naše nabídka zahrnující několik stovek produktů fitness a silových sportů se stále rozšiřuje o nová zařízení. Mnohokrát byla prezentována na „ISPO” v Mnichově, „FIBO” v Kolíně, „SPORT LIFE” v Brně, „FIWE” v Varšavě, „FIT EXPO” v Poznani. Dnes logo HMS je dokonale rozpoznatelné na evropském trhu fitness produktů.

Zvláštní místo v naší nabídce má exkluzivní série HMS Premium. Zařadili jsme ji do nabídky kvůli nejnáročnějším klientům. Její charakteristickou vlastností je využití materiálů vysoké jakosti, zaručujících dlouhou životnost. Ve spojení s nejlepšími standardy výroby a originálním designem je série HMS Premium zárukou neopakovatelných zážitků a satisfakce z tréninku.

Zveme Vás k seznámení se s naší nabídkou pro sezónu 2018/2019. Doufáme, že se pro Vás stane zdrojem nových možností a inspirace k další spolupráci se značkou HMS.

www.hms-fitness.pl





CHECK
OUR
INNOVATION





HMS[®]

ANYTHING IS POSSIBLE

SEMI
COMMERCIAL

GS
generator
system

electromagnetic
system



Wi-Fi



Rowery / Bikes / Rotopedy.....	7-15
Rowery poziome, rower powietrzny / Recumbent bikes, air bike / Horizontální rotopedy, vzduchový rotoped.....	17-21
Rowery spinningowe / Spin bikes / Cyklotrenažér.....	23-25
Orbitreki / Elliptical bikes / Eliptické trenažery.....	27-35
Bieżnie elektryczne / Electric treadmills / Elektrické běžecké pásy.....	37-41
Wioślarze / Rowing machines / Veslařské trenažéry.....	43-45
Masażery / Rowing machines / Masážní přístroj.....	46-47
Suwnice / Smith's machines / Multipressy.....	49-53
Atlasy / Home gyms / Posilovací věže.....	55-59
Uchwyty do wyciągu / Handles / Adaptéry ke kladkám.....	60-63
Ławki do ćwiczeń / Barbell benches / Cvičebni lavice.....	64-71
Steppery / Steppers / Steppery.....	72-75
Stepy / Aerobic step / Stepy	76-79
Maty / Fitness mat / Podložky	80-85
Piłki do jogi, piłki do balansowania, kločki do jogi / Yoga balls, balancing balls, yoga blocks / Gymnastické míče, balanční míče a podložky, jóga bloky.....	87-91
Rollery / Rollers / Posilovací kolečka.....	93-99
Wałki / Exercise wheels / Masážní válce.....	100-101
Gumy / Exercise band / Gumy.....	103-106
Ekspandery / Expanders / Expandéry.....	107-111
Krążki obrotowe / Figure trimmers / Rotační disky.....	112-113
Skakanki, ściskacze / Jump ropes, Hand grips / Švihadla, posilovače zápěstí.....	114-119
Trening cross / Cross trening / Crossový trénink.....	121-131
Sztangi body pump / Body pump / Sestavy body pump.....	133
Sztangi stałe / Handle bars / Kompletní činky.....	134
Gryfy / Bars / Hřídle.....	135-139
Akcesoria do gryfów / Bars accessories / Příslušenství k hřidelím.....	140
Łańcuchy / Bar chains / Řetězy.....	141
Akcesoria treningowe / Training accessories / Příslušenství.....	142-144
Talerze / Plates / Kotouče.....	145-148
Sztangielki / Humbells / Jednoručky.....	149-151
Sztangielki regulowane / Adjustable dumbbells set / Nastavitelná hřidel.....	152-153
Hantla / Dumbbell / Činka.....	155
Kettlebell / Kettlebells / Kettlebelly.....	156-158
Ciężarki / Dumbbells / Činky.....	159-161
Pasy treningowe / Training belts / Tréninkové pásy.....	162
Rękawiczki fitness / Fitness gloves / Fitness rukovice.....	163-164
Stojaki / Racks / Stojany.....	165-169
Ściągacze / Supports / Stahovala.....	170-175



PULS - SENSORY DOTYKOWE /
PULSE - TOUCH SENSORS /
SENZORY PRO MĚŘENÍ TEPOVÉ FREKVENCE

INNOWACYJNY KOMPUTER /
INNOVATIVE COMPUTER /
INOATIVNÍ POČÍTAČ

REGULACJA SIODEŁKA /
ADJUSTABLE SADDLE /
REGULACE SEDÁTKA

SYSTEM OPORU: ELEKTROMAGNETYCZNY /
RESISTANCE SYSTEM: ELECTROMAGNETIC /
SYSTÉM ODPORU: ELEKTROMAGNETICKÝ



M1844i



Electromagnetic bike

17-02-001



electromagnetic system



9

18 training programs



Maximum user weight 150 kg



M8512i



Magnetic bike

17-01-028



M1820i



Magnetic bike

17-01-023



12 training programs



24 training programs





M8601i



Magnetic bike
17-01-025



M0410i



Magnetic bike
17-01-027





M9239P



Magnetic bike
17-01-007



M9239i



Magnetic bike
17-01-006





M0907



Magnetic bike
17-01-029







M9239*



Magnetic bike
17-01-008









M9239V



Magnetic bike
17-01-009



M9239 PLUS



Magnetic bike
17-01-005





M9257



Magnetic bike

17-01-034



M6120



Magnetic bike

17-01-010



	Symbol / Model / Označení	M1844i	M1820i	M5812i	M8601i	M0410i	M9239P	M9239i	M0907	M9239*	M9239V	M9239 PLUS	M9257	M6120	
	Klasa dokładności / Accuracy class / Třída přesnosti	A ergometr	A ergometr	B	A ergometr	A ergometr	A ergometr	B	B	B	B	B	B	B	
	Klasa użytkowania / Class of use / Norma	H	H	H	H	H	H	H	H	H	H	H	H	H	
Parametry techniczne / Technical parameters / Parametry	System oporu / Resistance system / Systém odporu	Elektromagnetyczny / Electromagnetic / Elektromagnetický	Magnetyczny wewnętrzny / Inner magnetic / Vnitřní automatický	Magnetyczny wewnętrzny / Inner magnetic / Vnitřní automatický	Magnetyczny wewnętrzny / Inner magnetic / Vnitřní automatický	Magnetyczny zewnętrzny / Outer magnetic / Vnější magnetycký	Magnetyczny zewnętrzny / Outer magnetic / Vnější magnetycký	Magnetyczny zewnętrzny / Outer magnetic / Vnější magnetycký	Magnetyczny zewnętrzny / Outer magnetic / Vnější magnetycký	Magnetyczny zewnętrzny / Outer magnetic / Vnější magnetycký	Magnetyczny zewnętrzny / Outer magnetic / Vnější magnetycký	Magnetyczny zewnętrzny / Outer magnetic / Vnější magnetycký	Magnetyczny zewnętrzny / Outer magnetic / Vnější magnetycký	Magnetyczny zewnętrzny / Outer magnetic / Vnější magnetycký	
	Zakres obciążenia / Levels of resistance / Rozsah zatížení	1 - 32	1 - 32	1 - 32	1 - 16	1 - 12	1 - 16	1 - 8	1 - 8	1 - 8	1 - 8	1 - 8	1 - 8	1 - 8	
	Waga koła zamachowego (kg) / Flywheel weight (kg) / Zátěžové kolo (kg)	9	9	9	8	6	9	9	6	9	9	9	6	3,5	
	Regulacja oporu / Tension adjustment / Regulace odporu	Automatyczna / Automatic / Automatický	Automatyczna / Automatic / Automatický	Automatyczna / Automatic / Automatický	Automatyczna / Automatic / Automatický	Automatyczna / Automatic / Automatický	Automatyczna / Automatic / Automatický	Automatyczna / Automatic / Automatický	Manualna / Manual / Manuální	Manualna / Manual / Manuální	Manualna / Manual / Manuální	Manualna / Manual / Manuální	Manualna / Manual / Manuální	Manualna / Manual / Manuální	Manualna / Manual / Manuální
	Regulacja siodełka / Adjustable saddle / Regulace sedátka	Vertical / Horizontal	Vertical / Horizontal	Vertical / Horizontal	Vertical / Horizontal	Vertical / Horizontal	Vertical / Horizontal	Vertical / Horizontal	Vertical / Horizontal	Vertical / Horizontal	Vertical / Horizontal	Vertical / Horizontal	Vertical / Horizontal	Vertical / Horizontal	Vertical
	Regulacja kierownicy / Adjustable handlebar / Regulace řídítek	Inclination	Inclination	Inclination	Inclination	Inclination	Inclination	Inclination	Inclination	Inclination	Inclination	Inclination	Inclination	Inclination	-
	Puls - sensory dotykowe / Pulse - touch sensors / Senzory pro měření tepové frekvence	•	•	•	•	•	•	•	•	•	•	•	•	•	•
	Pas telemetryczny / Pulse - telemetry belt / Telemetrické měření tepové frekvence	-	-	-	-	-	-	-	-	-	-	-	-	-	-
	Zasilanie / Power supply / Napájení	230 V	230 V	230 V	230 V	230 V	230 V	230 V	Baterie / Batteries / Batterie	Baterie / Batteries / Batterie	Baterie / Batteries / Batterie	Baterie / Batteries / Batterie	Baterie / Batteries / Batterie	Baterie / Batteries / Batterie	Baterie / Batteries / Batterie
Wyposażenie dodatkowe / Additional equipment / Ostatní příslušenství	Uchwyt na urządzenie mobilne / Mobile device shelf / Úchyt pro mobilní telefon	•	•	•	-	•	•	•	-	-	-	-	-	•	
	Uchwyt na bidon / Bottle holder / Úchyt pro láhev	-	•	•	-	•	•	-	-	-	-	-	-	-	
	Uchwyt na ręcznik / Towel holder / Úchyt na ručník	-	•	-	-	-	-	•	-	-	-	-	-	-	
	Żelowe siodełko / Gel saddle / Gelové sedátko	-	-	-	-	-	-	•	-	-	-	-	-	-	
	Rolki/Kółka transportowe / Transportation wheels/rollers / Transportní kolečka	•	•	•	•	•	•	•	•	•	•	•	•	•	
Stopki poziomujące / Leveling feet / Vyrovnávací nožky	•	•	•	•	•	•	-	-	•	-	-	-	-	-	
Funkcje komputera / Computer features / Funkce počítače	Wymiary komputera (mm) / Computer dimensions (mm) / Rozměr počítače (mm)	217 x 296 x 75	280 x 205 x 65	275 x 208 x 70	280 x 205 x 66	270 x 195 x 55	330 x 260 x 70	260 x 175 x 60	200 x 160 x 50	220 x 180 x 50	220 x 180 x 50	220 x 180 x 50	220 x 180 x 50	230 x 151 x 40	
	Wyświetlacz / Screen / Zobrazení	LCD	LCD	LCD	LCD	LCD	LCD	LCD	LCD	LCD	LCD	LCD	LCD	LCD	
	Wymiary wyświetlacza (mm) / Screen dimensions (mm) / Velikost displeje (mm)	131 x 67	128 x 59	275 x 208 x 70	131 x 67	131 x 67	110 x 60	131 x 67	80 x 40	70 x 45	70 x 45	70 x 45	70 x 45	19 x 12 x 3	
Programy treningowe / Training programs / Tréninkové programy	18	24	12	20	12	21	3	-	-	-	-	-	-		

	Symbol / Model / Označení	M1844i	M1820i	M5812i	M8601i	M0410i	M9239P	M9239i	M0907	M9239*	M9239V	M9239 PLUS	M9257	M6120	
Funkcje komputera/ Computer features/ Funkce počítače	Programy indywidualne / User programs / Individuální programy	x	4	4	1	x	4	-	-	-	-	-	-	-	
	Watt	•	•	•	•	•	•	-	-	-	-	-	-	-	
	Aplikacje mobilne / App / Mobilní aplikace	iConsole	DelighTech Fitness APP	-	iConsole+	iConsole+	-	iBiking+	-	-	-	-	-	-	
	Temperatura zewnętrzna / Outside temperature / Venkovní teplota	-	•	-	-	-	-	-	-	-	-	-	-	-	
	Scan	•	•	•	•	•	•	•	•	•	•	•	•	•	
	Czas / Time / Čas	•	•	•	•	•	•	•	•	•	•	•	•	•	
	Prędkość / Speed / Rychlost	•	•	•	•	•	•	•	•	•	•	•	•	•	
	Dystans / Distance / Vzdálenost	•	•	•	•	•	•	•	•	•	•	•	•	•	
	Puls / Pulse	•	•	•	•	•	•	•	•	•	•	•	•	•	
	Kalorie / Calories	•	•	•	•	•	•	•	•	•	•	•	•	•	
	Recovery / Funkce recovery	•	•	•	•	•	•	-	-	-	-	-	-	-	
	Body fat / Funkce spalování	•	•	•	•	•	•	-	-	-	-	-	-	•	
	Wejście USB / USB/ Vstup USB	•	-	-	•	•	•	-	-	-	-	-	-	-	
	Wejście Audio / Audio Input / Vstup Audio	-	-	-	•	•	•	-	-	-	-	-	-	-	
Bluetooth	•	•	-	•	•	•	-	-	-	-	-	-	-		
Waga / Wymiary// Weight / Dimensions// Váha / Rozměry	Waga netto (kg) / Weight netto (kg) / Váha netto (kg)	39	36,5	40	32,7	26,7	24,5	24,5	23,5	23	23	23	20,5	16,5	
	Waga brutto (kg) / Weight brutto (kg) / Váha brutto (kg)	43,5	40	46	36,7	29,4	27,5	27,5	27,3	26	26	26	22,5	17,5	
	Max waga użytkownika (kg) / Max user weight (kg) / Maximální zatížení (kg)	150	150	150	120	150	120	120	120	120	120	120	120	120	100
	Wymiary produktu (cm) / Product dimensions (cm) / Rozměr výrobku (cm)	102 x 54 x 155	100 x 56 x 150	109 x 56 x 149	107 x 55 x 143	98,5 x 56 x 145	93 x 54,5 x 128,5	93 x 55 x 129	97 x 53,5 x 150	93 x 54,5 x 138	93 x 54,5 x 138	93 x 54,5 x 138	93 x 54,5 x 138	90*58*130	85 x 46 x 118
	Wymiary opakowania / Packaging dimensions (cm) / Rozměr balení	100 x 26 x 66	98 x 28 x 70	103,5 x 34,5 x 65,5	100 x 28 x 66	88 x 25 x 58	76 x 25,5 x 61	75 x 26 x 62	80 x 26 x 59	75 x 26 x 62	75 x 26 x 62	75 x 26 x 62	75 x 26 x 62	66,5*26*66	59 x 25 x 47
Ilość w kontenerze / Quantity in container / Počet v kontejneru 20'/40'/HQ40	162/342/408	128/288/337	117/237/272	147/309/368	224/474/520	252/537/564	252/537/564	260/537/590	252/537/564	252/537/564	252/537/564	252/537/564	249/528/627	405/797/983	



INNOWACYJNY KOMPUTER /
INNOVATIVE COMPUTER /
INOVATIVNÍ POČÍTAČ

PULS - SENZORY DOTYKOWE /
PULSE - TOUCH SENSORS /
SENZORY PRO MĚŘENÍ TEPOVÉ FREKVENCE

UCHWYT NA BIDON /
BOTTLE HOLDER /
ÚCHYT PRO LÁHEV

REGULACJA SIODEŁKA /
ADJUSTABLE SADDLE /
REGULACE SEDÁTKA

GENERATOR /
GENERATOR SYSTEM /
GENERÁTOR SYSTÉMU



R1817



SEMI
COMMERCIAL

Recumbent magnetic bike
with generator system

17-08-001





R8514i



Recumbent magnetic bike

17-00-000



R6800i



Recumbent magnetic bike

17-06-001



12 training programs



24 training programs





R9259



Recumbent magnetic bike

17-06-002



R9259 PLUS



Recumbent magnetic bike

17-06-005





R9254



Recumbent magnetic bike

17-06-003



- Flywheel weight 6 kg
- Maximum user weight 120 kg

R9203



Recumbent magnetic bike

17-06-004



- Flywheel weight 65 kg
- Maximum user weight 100 kg



MP6590



Air bike
17-03-100







SW8905



Spin bike

17-09-010



SW8902i



Spin bike

17-09-008



	Symbol / Model / Označení	R1817	R5814i	R6800i	R9259	R9259 PLUS	R9254	R9203	MP6590	SW 8905	SW 8902i
	Klasa dokładności / Accuracy class / Třída přesnosti	B	B	A ergometr	B	B	B	B	C	B	A
	Klasa użytkowania / Class of use / Norma	S	H	H	H	H	H	H	H	H	H
Parametry techniczne/ Technical parameters/ Parametry	System oporu / Resistance system / Systém odporu	Magnetyczny wewnętrzny / Inner magnetic / Vnitřní automatický	Magnetyczny wewnętrzny / Inner magnetic / Vnitřní automatický	Magnetyczny wewnętrzny / Inner magnetic / Vnitřní automatický	Magnetyczny zewnętrzny / Outer magnetic / Vnější magnetický	Magnetyczny zewnętrzny / Outer magnetic / Vnější magnetický	Magnetyczny zewnętrzny / Outer magnetic / Vnější magnetický	Magnetyczny zewnętrzny / Outer magnetic / Vnější magnetický	Powietrzny / Air system / Vzduchový systém	Mechaniczny / Mechanical / Mechanický	Mechaniczny / Mechanical / Mechanický
	Zakres obciążenia / Levels of resistance / Rozsah zatížení	1-32	1-32	1-24	1-8	1-8	1-8	1-8	-	Smooth	Smooth
	Waga koła zamachowego (kg) / Flywheel weight (kg) / Zátěžové kolo (kg)	9	9	7	9	9	6	6,5	-	15	18
	Regulacja oporu / Tension adjustment / Regulace odporu	Automatyczna / Automatic / Automatický	Automatyczna / Automatic / Automatický	Automatyczna / Automatic / Automatický	Manualna / Manual / Manuální	Manualna / Manual / Manuální	Manualna / Manual / Manuální	Manualna / Manual / Manuální	-	Manualna / Manual / Manuální	Manualna / Manual / Manuální
	Regulacja siodełka / Adjustable saddle / Regulace sedátka	Horizontal	Horizontal	Horizontal	Horizontal	Horizontal	Horizontal	Horizontal	Vertical	Vertical/Horizontal	Vertical/Horizontal
	Regulacja kierownicy / Adjustable handlebar / Regulace řídítek	-	Inclination	Inclination	-	-	-	Inclination	Vertical	-	Inclination
	Puls - sensory dotykowe / Pulse - touch sensors / Senzory pro měření tepové frekvence	•	•	•	•	•	•	•	•	-	-
	Pas telemetryczny / Pulse - telemetry belt / Telemetrické měření tepové frekvence	-	-	-	-	-	-	-	-	•	-
	Zasilanie / Power supply / Napájení	Generator	230 V	230 V	Baterie / Batteries / Baterie	Baterie / Batteries / Baterie	Baterie / Batteries / Baterie	Baterie / Batteries / Baterie	Baterie / Batteries / Baterie	Baterie / Batteries / Baterie	Baterie / Batteries / Baterie
	Wyposażenie dodatkowe/ Additional equipment/ Ostatní příslušenství	Uchyt na urządzenie mobilne / Mobile device shelf / Úchyt pro mobilní telefon	-	•	-	-	-	•	-	•	-
Uchyt na bidon / Bottle holder / Úchyt pro láhev		-	•	-	-	-	-	-	-	•	•
Uchyt na ręcznik / Towel holder / Úchyt na ručník		-	-	-	-	-	-	-	-	-	-
Żelowe siodełko / Gel saddle / Gelové sedátko		-	-	-	-	-	-	-	-	-	-
Rolki/Kółka transportowe / Transportation wheels/rollers / Transportní kolečka		•	•	•	•	•	•	•	•	•	•
Stopki poziomujące / Leveling feet / Vyrovnávací nožky	-	•	•	x	-	-	-	-	•	•	
Funkcje komputera/ Computer features/ Funkce počítače	Wymiary komputera (mm) / Computer dimensions (mm) / Rozměr počítače (mm)	217 x 296 x 75	270 x 205 x 70	280 x 195 x 35	220 x 180 x 50	220 x 180 x 50	203 x 171 x 28	170 x 140 x 40	190 x 120 x 30	179 x 120 x 36	145 x 95 x 45
	Wyświetlacz/ Screen/ Zobrazení	LCD	LCD	LCD	LCD	LCD	LCD	LCD	LCD	LCD	-
	Wymiary wyświetlacza (mm) / Screen dimensions (mm) / Velikost displeje (mm)	131 x 67	131 x 67	128 x 59	70 x 50	70 x 50	75 x 42	50 x 20	19 x 12 x 3	78 x 48	-
	Programy treningowe / Training programs / Tréninkové programy	19	12	24	-	-	-	-	-	-	-



	Symbol / Model / Označení	R1817	R5814i	R6800i	R9259	R9259 PLUS	R9254	R9203	MP6590	SW 8905	SW 8902i	
Funkcje komputera/ Computer features/ Funkce počítače	Programy indywidualne / User programs / Individuální programy	-	4	1	-	-	-	-	-	-	-	
	Watt	•	•	•	-	-	-	-	-	-	-	
	Aplikacje mobilne / App / Mobilní aplikace	-	-	DelighTech Fitness APP	-	-	-	-	-	-	iBiking+	
	Temperatura zewnętrzna / Outside temperature / Venkovní teplota	-	-	•	-	-	•	-	-	-	-	
	Scan	•	•	•	•	•	-	•	•	•	-	
	Czas / Time / Čas	•	•	•	•	•	•	•	•	•	-	
	Prędkość / Speed / Rychlost	•	•	•	•	•	•	•	•	•	-	
	Dystans / Distance / Vzdálenost	•	•	•	•	•	•	•	•	•	•	-
	Puls / Pulse	•	•	•	•	•	•	•	•	•	•	-
	Kalorie / Calories	•	•	•	•	•	•	•	•	•	-	-
	Recovery / Funkce recovery	•	•	•	-	-	•	-	-	-	-	-
	Body fat / Funkce spalování	•	•	•	-	-	•	-	•	-	-	-
	Wejście USB / USB / Vstup USB	•	-	-	-	-	-	-	-	-	-	-
	Wejście Audio / Audio Input / Vstup Audio	-	-	-	-	-	-	-	-	-	-	-
	Bluetooth	-	-	•	-	-	-	-	-	-	-	•
Waga / Wymiary// Weight / Dimensions// Váha / Rozměry	Waga netto (kg) / Weight netto (kg) / Váha netto (kg)	58,5	52,5	35,6	28,5	28,5	25	21,5	27	42	43,5	
	Waga brutto (kg) / Weight brutto (kg) / Váha brutto (kg)	63,5	63,5	38,4	32,5	32,5	28,5	24,5	30	45	51,2	
	Max waga użytkownika (kg) / Max user weight (kg) / Maximální zatížení (kg)	180	150	120	120	120	120	100	110	120	120	
	Wymiary produktu (cm) / Product dimensions (cm) / Rozměr výrobku (cm)	173 x 67 x 112	154,5 x 32,5 x 7,05 cm	136,5 x 58 x 126	65 x 98 x 142	65 x 98 x 142	138 x 65 x 98	126 x 63 x 92	111 x 65 x 163	124 x 96 x 116	130 x 58 x 130	
	Wymiary opakowania / Packaging dimensions (cm) / Rozměr balení	168 x 27 x 72	158 x 35 x 74 cm	94 x 33 x 67	99 x 29 x 56	99 x 29 x 56	99 x 29 x 59	97 x 26 x 53	100 x 25 x 66,5	114 x 86 x 26	120 x 26,5 x 88	
Ilość w kontenerze / Quantity in container / Počet v kontejneru 20'/40'/HQ40	78/168/182	68/141/162	144/288/336	176/384/432	176/384/432	176/384/432	224/448/550	164/350/417	107/223/261	103/207/251		



PULS - SENSORY DOTYKOWE /
PULSE - TOUCH SENSORS /
SENZORY PRO MĚŘENÍ TEPOVÉ FREKVENCE

INNOWACYJNY KOMPUTER /
INNOVATIVE COMPUTER /
INOVATIVNÍ POČÍTAČ

UCHWYT NA BIDON /
BOTTLE HOLDER /
ÚCHYT PRO LÁHEV

GENERATOR /
GENERATOR SYSTEM /
GENERÁTOR SYSTÉMU

REGULACJA DŁUGOŚCI KROKU /
STEP LENGTH ADJUSTMENT /
NASTAVENÍ DÉLKY KROKU



H1742



SEMI
COMMERCIAL

Magnetic elliptical trainer
with generator system

17-12-015





H1833i



Electromagnetic elliptical trainer
17-13-001



H1708i



Magnetic elliptical trainer
17-12-014



electromagnetic system



16 training programs



16 training programs





H5813i



Magnetic elliptical trainer

17-12-018



H1830i



Magnetic elliptical trainer

17-12-013





H8602i



Magnetic elliptical trainer

17-12-012



H6191



Magnetic elliptical trainer

17-12-016





H0103i



Magnetic elliptical trainer
17-12-011



H9249*



Magnetic elliptical trainer
17-12-010





H9249V



Magnetic elliptical trainer

17-12-017



H9244



Magnetic elliptical trainer

17-12-009

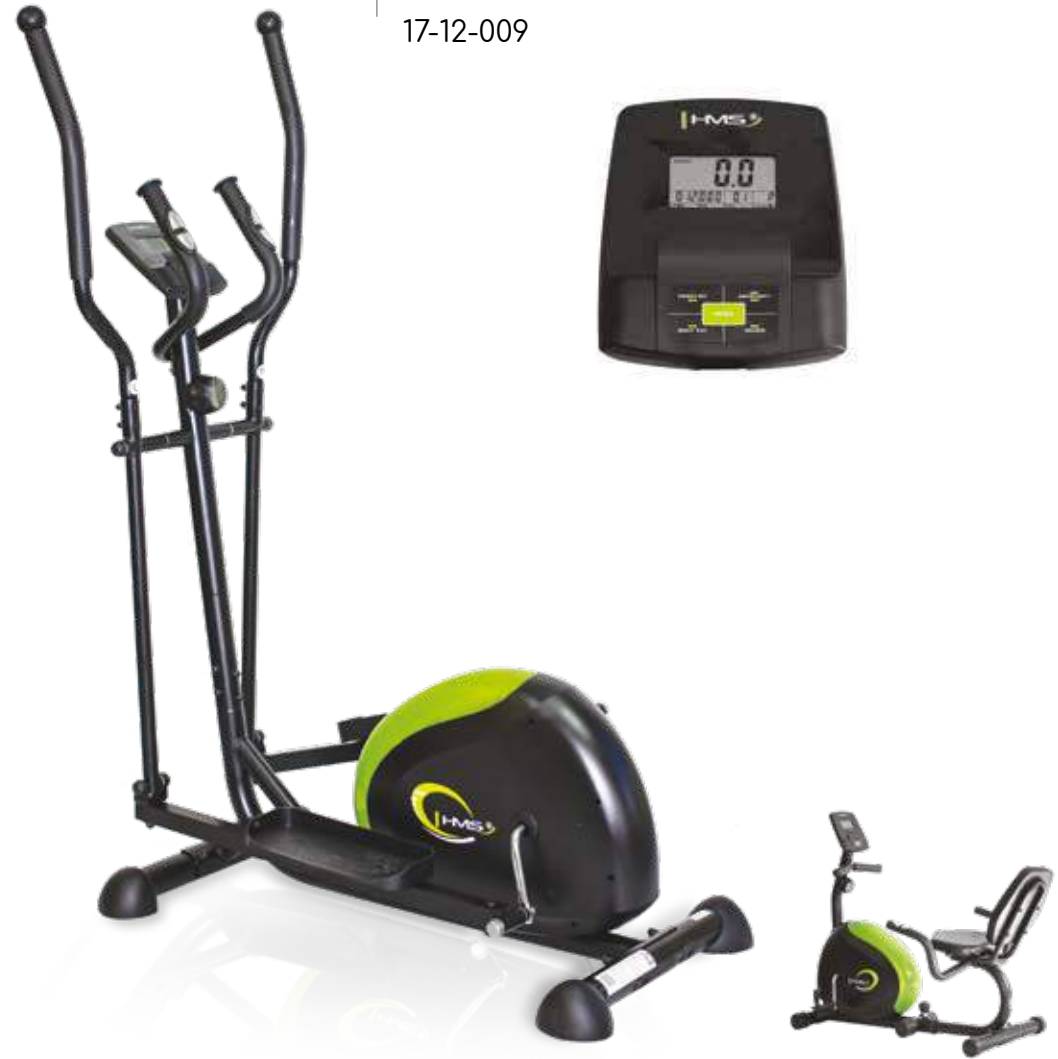

- Brake system
- Flywheel weight 9 kg
- Maximum user weight 120 kg

- Brake system
- Flywheel weight 8 kg
- Maximum user weight 100 kg



H6512



Magnetic elliptical trainer
17-11-011



HP6513



Air elliptical trainer
17-15-000



	Symbol / Model / Označení	H1742	H1833i	H1708i	H5813i	H1830i	H8602i	H6191	H0103	H9249	H9249V	H9244	H6512	HP6513	
	Klasa dokładności / Accuracy class / Třída přesnosti	A	A ergometr	A ergometr	B	A ergometr	A ergometr	B	A ergometr	B	B	B	C	C	
	Klasa użytkowania / Class of use / Norma	S	H	H	H	H	H	H	H	H	H	H	H	H	
Parametry techniczne/ Technical parameters/ Parametry	System oporu / Resistance system / Systém odporu	Magnetyczny wewnętrzny / Inner magnetic / Vnitřní automatický	Elektromagnetyczny / Electromagnetic / Elektromagnetický	Magnetyczny zewnętrzny / Outer magnetic / Vnější magnetycký	Magnetyczny wewnętrzny / Inner magnetic / Vnitřní automatický	Magnetyczny zewnętrzny / Outer magnetic / Vnější magnetycký	Magnetyczny wewnętrzny / Inner magnetic / Vnitřní automatický	Magnetyczny wewnętrzny / Inner magnetic / Vnitřní automatický	Magnetyczny wewnętrzny / Inner magnetic / Vnitřní automatický	Magnetyczny zewnętrzny / Outer magnetic / Vnější magnetycký	Magnetyczny zewnętrzny / Outer magnetic / Vnější magnetycký	Magnetyczny zewnętrzny / Outer magnetic / Vnější magnetycký	Magnetyczny zewnętrzny / Outer magnetic / Vnější magnetycký	Mechaniczny / Mechanical / Mechanický	Powietrzny / Air system / Vzduchový systém
	Zakres obciążenia / Levels of resistance / Rozsah zatížení	1-32	1-16	1-16	1-32	1-16	1-16	1-8	1-12	1-8	1-8	1-8	Smooth	Smooth	
	Waga koła zamachowego (kg) / Flywheel weight (kg) / Zátěžové kolo (kg)	9	10	8	9	10	8	7	7	9	9	8	7	-	
	Regulacja oporu / Tension adjustment / Regulace odporu	Automatyczna / Automatic / Automatický	Automatyczna / Automatic / Automatický	Automatyczna / Automatic / Automatický	Automatyczna / Automatic / Automatický	Automatyczna / Automatic / Automatický	Automatyczna / Automatic / Automatický	Automatyczna / Automatic / Automatický	Manualna / Manual / Manuální	Automatyczna / Automatic / Automatický	Manualna / Manual / Manuální	Manualna / Manual / Manuální	Manualna / Manual / Manuální	Manualna / Manual / Manuální	Manualna / Manual / Manuální
	Regulacja długości kroku / Step length adjustment / Nastavení délky kroku	-	-	-	-	-	-	-	-	-	-	-	-	-	-
	Regulacja uchwytów / Adjustable handle / Regulace rukojeti	-	•	•	-	•	-	-	-	-	-	-	-	-	-
	Regulacja pedałó / Adjusting the pedals / Regulace pedálů	•	•	•	-	•	-	-	-	-	-	-	-	-	-
	Puls - sensory dotykowe / Pulse - touch sensors / Senzory pro měření tepové frekvence	•	•	•	•	•	•	•	•	•	•	•	•	•	•
	Pas telemetryczny / Pulse - telemetry belt / Telemetrické měření tepové frekvence	-	•	•	-	•	-	-	-	-	-	-	-	-	-
	Zasilanie / Power supply / Napájení	Gnerator +230 V	230 V	230 V	230 V	230 V	230 V	230 V	230 V	230 V	Baterie / Batteries / Batterie	Baterie / Batteries / Batterie	Baterie / Batteries / Batterie	Baterie / Batteries / Batterie	Baterie / Batteries / Batterie
Wyposażenie dodatkowe/ Additional equipment/ Ostatní příslušenství	Uchwyt na urządzenie mobilne / Mobile device shelf / Úchyt pro mobilní telefon	•	•	•	•	•	•	•	-	-	-	-	•	•	
	Uchwyt na bidon / Bottle holder / Úchyt pro láhev	•	-	-	•	•	-	•	-	-	-	-	-	-	
	Uchwyt na ręcznik / Towel holder / Úchyt na ručník	-	-	-	-	-	-	-	-	-	-	-	-	-	
	Rolki/Kółka transportowe / Transportation wheels/rollers / Transportní kolečka	•	•	•	•	•	•	•	•	•	•	•	•	•	•
	Stopki poziomujące / Leveling feet / Vyrovnávací nožky	•	•	•	•	•	•	•	•	•	•	•	•	•	•
Funkcje komputera/ Computer features/ Funkce počítače	Wymiary komputera (mm) / Computer dimensions (mm) / Rozměr počítače (mm)	355 x 272 x 110	217 x 296 x 75	217 x 296 x 75	275 x 208 x 70	280 x 205 x 65	280 x 205 x 66	270 x 195 x 55	280 x 205 x 65	220 x 180 x 50	220 x 180 x 50	203 x 171 x 28	230 x 151 x 40	230 x 151 x 40	
	Wyświetlacz/ Screen/ Zobrazení	LCD	LCD	LCD	LCD	LCD	LCD	LCD	LCD	LCD	LCD	LCD	LCD	LCD	



	Symbol / Model / Označení	H1742	H1833i	H1708i	H5813i	H1830i	H8602i	H6191	H0103	H9249	H9249V	H9244	H6512	HP6513	
	Wymiary wyświetlacza (mm) / Screen dimensions (mm) / Velikost displeje (mm)	131 x 67	131 x 67	131 x 67	131 x 67	128 x 59	131 x 67	131 x 67	128 x 59	70 x 50	70 x 50	72 x 42	19 x 12 x 3	19 x 12 x 3	
	Programy treningowe / Training programs / Tréninkové programy	12	16	16	12	24	12	12	24	-	-	-	-	-	
	Programy indywidualne / User programs / Individuální programy	1	-	-	4	1	1	1	1	-	-	-	-	-	
	Watt	0-999	0-999	0-999	0-999	0-999	0-999	0-999	0-999	-	-	-	-	-	
	Aplikacje mobilne/ App / Mobilní aplikace	-	iConsole+	iConsole+	-	DelighTech Fitness APP	iConsole+	Fit Hi Way	DelighTech Fitness APP	-	-	-	-	-	
Funkcje komputera/ Computer features/ Funkce počítače	Temperatura zewnętrzna / Outside temperature / Venkovní teplota	-	-	-	-	•	-	-	-	-	-	•	-	-	
	Scan	•	•	•	•	•	•	-	•	•	•	•	•	•	
	Czas / Time / Čas	•	•	•	•	•	•	•	•	•	•	•	•	•	
	Prędkość / Speed / Rychlost	•	•	•	•	•	•	•	•	•	•	•	•	•	
	Dystans / Distance / Vzdálenost	•	•	•	•	•	•	•	•	•	•	•	•	•	
	Puls / Pulse	•	•	•	•	•	•	•	•	•	•	•	•	•	
	Kalorie / Calories	•	•	•	•	•	•	•	•	•	•	•	•	•	
	Recovery / Funkce recovery	•	•	•	•	•	•	•	•	•	-	-	-	-	
	Body fat / Funkce spalování	•	•	•	•	•	•	•	•	•	-	-	-	•	•
	Wejście USB / USB/ Vstup USB	•	•	•	-	-	•	-	-	-	-	-	-	-	-
	Wejście Audio / Audio Input / Vstup Audio	•	-	-	-	-	-	•	-	-	-	-	-	-	-
	Bluetooth	-	•	•	-	•	•	•	•	•	-	-	-	-	-
	Głośniki / Built-in speakers / Bezpečnostní system	•	-	-	-	-	-	-	-	-	-	-	-	-	-
	Wentylator / Ventilator / Ventilator	•	-	-	-	-	-	-	-	-	-	-	-	-	-
	Mp3	•	-	-	-	-	-	-	-	-	-	-	-	-	-
	Waga / Wymiary// Weight / Dimensions// Váha / Rozměry	Waga netto/brutto (kg) / Weight netto/brutto (kg) / Váha netto/brutto (kg)	76,5/83,5	51/57,5	55,5/60,5	58/70	51/60,5	42/47,5	43,9/48	33,5/38,5	32/36,5	32/36,5	31/35	30/32	27/30
Max waga użytkownika (kg) / Max user weight (kg) / Maximální zatížení (kg)		180 kg	150 kg	150 kg	150 kg	150 kg	120 kg	110 kg	120 kg	120 kg	120 kg	100 kg	110 kg	110 kg	
Wymiary produktu (cm) / Product dimensions (cm) / Rozměr výrobku (cm)		173 x 65 x 158	145 x 62 x 155	152 x 64 x 156	166 x 70 x 158	127 x 58 x 160	129 x 60 x 165	142 x 59,5 x 157	114 x 58 x 154	130 x 60 x 158	130 x 60 x 158	130 x 62 x 157	92,3 x 61,3 x 132,6	111 x 65 x 163	
Wymiary opakowania / Packaging dimensions (cm) / Rozměr balení		115 x 44 x 183	140 x 44 x 67	132 x 38 x 65	138,5 x 38 x 74,5	128,5 x 42 x 59	116 x 45 x 58	128 x 38,5 x 65	103 x 32 x 53	103 x 33 x 56	103 x 33 x 56	103 x 33 x 53	98 x 22,5 x 66,5 cm	100 x 25 x 66,5 cm	
Ilość w kontenerze / Quantity in container / Počet v kontejneru 20'/40'/HQ40		75/150/183	66/132/157	68/145/185	72/152/176	240/495/534	99/200/230	107/214/216	155/334/358	148/316/360	148/316/360	148/316/395	197/396/457	164/350/417	



WENTYLATOR /
FAN /
VENTILÁTOR

PULS - SENZORY DOTYKOWE /
PULSE - TOUCH SENSORS /
SENZORY PRO MĚŘENÍ TEPOVÉ FREKVENCE

INNOWACYJNY KOMPUTER /
INNOVATIVE COMPUTER /
INOVATIVNÍ POČÍTAC

AUTOMATYCZNA REGULACJA NACHYLENIA /
AUTOMATIC INCLINE ADJUSTMENT /
NASTAVENÍ NÁKLONU AUTOMATICKÝ

AMORTYZACJA /
AMORTISATION OF THE RUNNING BELT /
AMORTIZACE



BE6000



SEMI
COMMERCIAL

Electric treadmill
17-19-015



- ENGINE POWER 2,0 (Peak)
- TOUCH PANEL HD TV
- 12 training programs
- Bluetooth
- Wi-Fi
- USB
- MP3
- MP3
- Heart rate monitor
- Maximum user weight 150 kg



BE8510i



Electric treadmill
17-19-009



ENGINE POWER 3.5 HP
TOUCH PANEL
99 training programs
running
Bluetooth
SD card
USB
AUX IN
MP3
Maximum load 180 kg



BE8535



Electric treadmill

17-19-008



BE5000i



Electric treadmill

17-19-007





BE4500



Electric treadmill
17-19-004



BE4200



Electric treadmill
17-19-002



ENGINE POWER 2.5 (CV) 18 training programs Maximum user weight 115 kg

ENGINE POWER 1.25 (CV) Maximum user weight 100 kg

	Symbol / Model / Označení	BE6000	BE8510i	BE8535	BE5000i	BE4500	BE4200
	Klasa dokładności / Accuracy class / Třída přesnosti	B	A	A	A	A	c
	Klasa użytkowania / Class of use / Norma	S	H	H	H	H	H
Parametry techniczne / Technical parameters / Parametry	Typ napędu elektryczny / Electric drive / Typ pohonu elektrický	•	•	•	•	•	•
	Silnik - moc znamionowa (HP) / Engine (HP) / Motor (HP)	2,0	3,5	3,5	3,5	2,5	1,25
	Zakres prędkości (km/h) / Levels of speed adjustment / Rozsah náklonu	1-22	1-22	1-22	1-18	1-16	1-10
	Zakres kąta nachylenia / Levels of incline adjustment / Rozsah náklonu	0-15	0-22	0-22	0-15	0-15	-
	Wymiary pasa bieżnego (cm) / Running belt dimensions (cm) / Rozměry běžecké plochy (cm)	52 x 150	53,5x138	53,5x135	52x140	43x130	40x120
	Regulacja prędkości automatyczna / Automatic speed adjustment / Nastavení rychlosti automatický	•	•	•	•	•	•
	Automatyczna regulacja nachylenia / Automatic incline adjustment / Nastavení náklonu automatický	•	•	•	•	•	-
	Możliwość składania / Foldable / Možnost složení	•	•	•	•	•	•
	System bezpiecznego rozkładania bieżni / Safe folding system / Systém spouštění plochy	•	•	•	•	•	-
	Amortyzacja / Amortisation of the running belt / Amortizace	•	•	•	•	•	-
	Pomiar tętna - sensory dotykowe / Pulse - touch sensors / Senzory pro měření tepové frekvence	•	•	•	•	•	-
	Pomiar tętna - Pas telemetryczny / Pulse - telemetry belt / Telemetrické měření tepové frekvence	-	•	-	•	-	-
	Zasilanie / Power supply / Napájení	230 V	230 V	230 V	230 V	230 V	230 V
	Wyposażenie dodatkowe / Additional equipment / Ostatní příslušenství	Uchwyt na urządzenie mobilne / Mobile device shelf / Úchyt pro mobilní telefon	•	•	-	•	-
Uchwyt na bidon / Bottle holder / Úchyt pro láhev		•	•	-	•	-	-
Wbudowane głośniki / Built-in speakers / Vbudované reproduktory		•	•	-	•	-	-
System bezpieczeństwa / Safety key / Bezpečnostní systém		•	•	•	•	•	•
Wentylator / Fan / Ventilátor		-	•	-	•	-	-

	Symbol / Model / Označení	BE6000	BE8510i	BE8535	BE5000i	BE4500	BE4200
Wyposażenie dodatkowe / Additional equipment / Ostatní příslušenství	Komputer / Computer / Počítač	•	•	•	•	•	•
	Rozmiar ekranu / Screen size / Velikost obrazovky	15,6"	2,6"	2,7"	4,7"	4,7"	3,6"
	Wyświetlacz / Screen / Zobrazení	LCD HDTV Touch Panel	LCD Touch Panel	LCD Touch Panel	LED	LCD	LCD
Parametry techniczne / Technical parameters / Parametry	Programy treningowe / Training programs / Tréninkové programy	12	99	99	18	18	-
	Programy indywidualne / User programs / Individuální programy	3	3	3	5	-	-
	Aplikacje mobilne / App / Mobilní aplikace	-	iRunning+	-	DelighTech Fitness APP	-	-
	Scan	-	•	•	-	•	-
	Czas / Time / Čas	•	•	•	•	•	•
	Prędkość / Speed / Rychlost	•	•	•	•	•	•
	Dystans / Distance / Vzdálenost	•	•	•	•	•	•
	Puls / Pulse	•	•	•	•	•	•
	Kalorie / Calories	•	•	•	•	•	•
	Recovery / Funkce recovery	•	•	•	•	-	-
	Body fat / Funkce spalování	•	•	•	-	-	-
	Wejście USB / USB / Vstup USB	•	•	•	•	-	-
	Wejście Audio / Audio Input / Vstup Audio	•	•	•	•	-	-
	Karta SD / SD card / SD karta	-	•	•	-	-	-
Bluetooth	•	•	-	•	-	-	
Mp3	•	•	-	•	-	-	
Wi-Fi	•	-	-	-	-	-	
Wyposażenie dodatkowe / Additional equipment / Ostatní příslušenství	Waga netto/brutto (kg) / Weight netto/brutto (kg) / Váha netto/brutto (kg)	136/161,5	97/105	88/100	91/100	66/75	40/46
	Max waga użytkownika (kg) / Max user weight (kg) / Maximální zatížení (kg)	150	180	180	150	115	100
	Wymiary produktu (cm) / Product dimensions (cm) / Rozměr výrobku (cm)	209*93*162	190 x 86 x 146	186 x 85 x 135	185 x 82 x 135	167 x 73 x 131	160 x 68 x 130
	Wymiary opakowania (cm) / Packaging dimensions (cm) / Rozměr balení (cm)	217 x 94 x 38 107 x 102 x 45	201 x 89 x 41	190 x 88 x 36	198 x 88 x 38	182 x 78 x 29	161 x 77 x 23
	Ilość w kontenerze / Quantity in container / Počet v kontejneru 20'/40'/HQ40	22/47/54	30/65/78	30/78/91	40/85/97	75/153/172	110/219/240

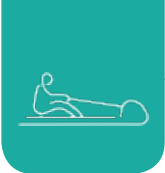

SYSTEM HAMOWANIA: MAGNETYCZNY WEWNĘTRZNY /
BRAKING SYSTEM: INNER MAGNETIC /
SYSTEM ZATÍŽENÍ: VNITŘNÍ AUTOMATICKÝ

PODSTAWKI POD STOPY /
FOOT PADS /
OPĚRY NOHOU

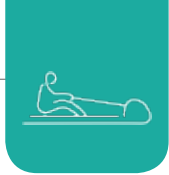

ZW1600



SEMI
COMMERCIAL

Water rowing machine
17-22-370



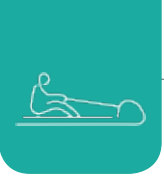

ZM1801



Magnetic rowing machine

17-22-301



ZM1502



Magnetic rowing machine

17-22-302



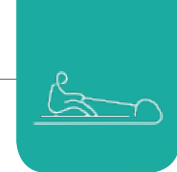

Model / Model / Třída	ZW1600	ZM1801	ZM1502
	Wioślarz wodny / Water rowing machine / Veslovači trenážer	Wioślarz magnetyczny / Magnetic rowing machine / Magnetický veslařský trenážer	Wioślarz magnetyczny / Magnetic rowing machine / Magnetický veslařský trenážer
Klasa dokladności / Accuracy class / Třída přesnosti	B	B	B
Klasa użytkowania / Class of use / Norma	S	H	H
System hamowania / Braking system / Systém zatížení	Wodny / Water tension / Vodní	Magnetyczny wewnętrzny / Inner magnetic / Vnitřní automatický	Magnetyczny wewnętrzny / Inner magnetic / Vnitřní automatický
Zakres obciążenia / Levels of resistance / Rozsah zatížení	1-9	1-8	1-8
Waga koła zamachowego (kg) / Flywheel weight (kg) / Zátěžové kolo (kg)	-	6	6
Regulacja oporu / Tension adjustment / Regulace odporu	smooth	Manualna / Manual / Manuální	Manualna / Manual / Manuální
Pomiar tętna - pas telemetryczny / Pulse - telemetry belt / Telemetrické měření tepové frekvence	•	•	•
Zasilanie / Power supply / Napájení	Baterie / Batteries / Baterie	Baterie / Batteries / Baterie	Baterie / Batteries / Baterie
Możliwość składania / Foldable / Možnost složení	•	•	•
Rolki transportowe / Transportation wheels / Transportní kolečka	•	-	-
Podstawki pod stopy z przodu / Supports for the feet / Opěry nohou	•	•	-
Pas telemetryczny / Pulse - telemetry belt / Telemetrické měření tepové frekvence	•	-	-
Wymiary komputera / Computer dimensions / Rozměr počítače	11,8 x 17,8 x 4,3 cm	10,5 x 11 cm	9 x 12 cm
Wyświetlacz / Screen / Zobrazení	LCD	LCD	LCD
Wymiary wyświetlacza / Screen dimensions / Velikost displeje	12,8 x 5,9 cm	7,8 x 4,5 cm	7,5 x 4,5 cm
Temp. zewnętrzna / Outside temperature / Venkovní teplota	•	-	-
Liczba pociągnięć / Strokes / Opakování	•	•	•
RPM	•	•	•
Scan	•	•	-
Czas / Time / Čas	•	•	•
Prędkość / Speed / Rychlost	•	-	-
Dystans / Distance / Vzdálenost	•	-	-
Puls	•	•	•
Kalorie / Calories / Kalorie	•	•	•
Waga netto / brutto / Weight netto/brutto / Hmotnost produktu netto/brutto	27.38 / 38.92 kg / 3.63 / 4.21 kg	28,2 kg	24,5 kg
Maks.waga użytkownika /Max user weight / Max. zatížení	150 kg	120 kg	120 kg
Wymiary produktu / Product dimensions / Rozměr výrobku	211.5 x 52 x 85 cm	191 x 60 x 49 cm	191 x 60 x 49 cm
Wymiary opakowania / Packaging dimensions / Rozměr balení	97 x 56.5 x 57.5 cm / 127 x 13.5 x 8 cm	127 x 29 x 50 cm	122 x 28 x 47 cm
Ilość w kontenerze 20'/40'/40 HQ / Quantity in container 20'/40'/40HQ / Počet v kontejneru 20'/40'/40HQ	96/192/220	152/328/360	180/380/420





MA1001



Massager
17-22-201





MA1020



Massager

17-22-200



Model / Model / Třída	MA1001	MA1020
	Masażer stojący / Massager / Vibromasažní pás	Masażer stojący / Massager / Vibromasažní pás
Trzy rodzaje pasów masujących / Three types of of massage belts / Tři typy masážních pásů	•	•
Klasa produktu / Product class / Třída produktu	H	H
Podstawa /Base / Základna	Szklana / Glass / Sklo	Szklana / Glass / Sklo
Liczba programów / No. Of programs / Počet programů	6	5
Liczba prędkości / No. Of speed / Počet rychlostí	16	20
Funkcje komputera / Computer functions / Funkce počítače	Czas, Kalorie, Prędkość / Time, Calories, Speed / Čas, Kalorie, Rychlost	Czas, Kalorie, Prędkość / Time, Calories, Speed / Čas, Kalorie, Rychlost
Wymiary produktu / Item size / Rozměry produktu	109 x 71 x 42,5 cm	120 x 72 x 44 cm
Maksymalna waga użytkownika / Maximum user weight / Maximální uživatelská hmotnost	120 kg	120 kg
Waga netto / brutto / Weight netto/brutto / Hmotnost produktu netto/brutto	20 / 23 kg	20 / 23 kg
Wymiary opakowania / Packing dimensions / Rozměry balení	80 x 26 x 45 cm	81 x 26 x 45 cm
Ilość w kontenerze 20'/40'/40HQ / Q-ty in container 20'/40'/40HQ / Množství v kontejneru 20'/40'/40HQ	270 / 560 / 620	270 / 560 / 620





Cyklop 2



SEMI
COMMERCIAL

Smith's machine
17-51-101





Cyklop 1



SEMI
COMMERCIAL

Smith's machine
17-51-100



Maximum
load weight
160 kg



Atlas X2



Smith's machine
17-51-002



Maximum
user weight
135 kg



Atlas X1



Smith's machine
17-51-001



Maximum
user weight
135 kg



Model / Model / Třída	CYKLOP2 SEMI COMMERCIAL	CYKLOP1 SEMI COMMERCIAL	ATLAS X2	ATLAS X1
	Suwnica Smitha / Smith's machine / Klec atlas	Suwnica Smitha / Smith's machine / Klec atlas	Suwnica Smitha / Smith's machine / Klec atlas	Suwnica Smitha / Smith's machine / Klec atlas
	<p>Suwnica CYKLOP 1 HMS to urządzenie do kompleksowego treningu całego ciała. Jego wszechstronne wyposażenie pozwala harmonijnie rozwijać zarówno górne, jak i dolne partie mięśniowe. Tylko od użytkownika zależy, jak zbuduje swój zestaw ćwiczeń w poszukiwaniu optymalnej formuły treningu.</p> <p>CYKLOP 1 HMS is a device for comprehensive training of the whole body. It is extensive equipment allows harmoniously develop both the upper and lower parts of the muscle. It's up to the user to decide how to build a set of exercises to find the optimal formula.</p> <p>CYKLOP 1 HMS je zařízení sloužící ke komplexnímu posilování celého těla. Všeestranné vybavení této posilovací věže umožňuje harmonicky rozvíjet jak horní, tak spodní svalové partie těla. Jen na uživateli záleží, jaké cviky zvolí za účelem vytvoření optimální formy tréninku.</p>	<p>Suwnica CYKLOP 2 HMS to urządzenie do kompleksowego treningu całego ciała. Jego wszechstronne wyposażenie pozwala harmonijnie rozwijać zarówno górne, jak i dolne partie mięśniowe. Tylko od użytkownika zależy, jak zbuduje swój zestaw ćwiczeń w poszukiwaniu optymalnej formuły treningu.</p> <p>CYKLOP 2 HMS is a device for comprehensive training of the whole body. It is extensive equipment allows harmoniously develop both the upper and lower parts of the muscle. It's up to the user to decide how to build a set of exercises to find the optimal formula.</p> <p>CYKLOP 2 HMS je zařízení sloužící ke komplexnímu posilování celého těla. Všeestranné vybavení této posilovací věže umožňuje harmonicky rozvíjet jak horní, tak spodní svalové partie těla. Jen na uživateli záleží, jaké cviky zvolí za účelem vytvoření optimální formy tréninku.</p>	<p>Suwnica Atlas X2 HMS to urządzenie do kompleksowego treningu całego ciała. Jego wszechstronne wyposażenie pozwala harmonijnie rozwijać zarówno górne, jak i dolne partie mięśniowe. Tylko od użytkownika zależy, jak zbuduje swój zestaw ćwiczeń w poszukiwaniu optymalnej formuły treningu.</p> <p>Atlas HMS X2 is a device for comprehensive training of the whole body. It is extensive equipment allows harmoniously develop both the upper and lower parts of the muscle. It's up to the user to decide how to build a set of exercises to find the optimal formula.</p> <p>Atlas HMS X2 je zařízení sloužící ke komplexnímu posilování celého těla. Všeestranné vybavení této posilovací věže umožňuje harmonicky rozvíjet jak horní, tak spodní svalové partie těla. Jen na uživateli záleží, jaké cviky zvolí za účelem vytvoření optimální formy tréninku.</p>	<p>Suwnica Atlas X2 HMS to urządzenie do kompleksowego treningu całego ciała. Jego wszechstronne wyposażenie pozwala harmonijnie rozwijać zarówno górne, jak i dolne partie mięśniowe. Tylko od użytkownika zależy, jak zbuduje swój zestaw ćwiczeń w poszukiwaniu optymalnej formuły treningu.</p> <p>Atlas HMS X1 is a device for comprehensive training of the whole body. It is extensive equipment allows harmoniously develop both the upper and lower parts of the muscle. It's up to the user to decide how to build a set of exercises to find the optimal formula.</p> <p>Atlas HMS X1 je zařízení sloužící ke komplexnímu posilování celého těla. Všeestranné vybavení této posilovací věže umožňuje harmonicky rozvíjet jak horní, tak spodní svalové partie těla. Jen na uživateli záleží, jaké cviky zvolí za účelem vytvoření optimální formy tréninku.</p>
Średnica uchwytów na wolny ciężar / Diameter of the grips for free weight / Průměr držáky jednotlivých hmotností	50/25 mm	50/25 mm	50/25 mm	50/25 mm
Długość gryfu / Grip length / Délka hřidel	194 cm	194 cm	196 cm	194 cm
Średnica gryfu / Grip diameter / Průměr hřidel	31 mm	31 mm	25 mm	25 mm
Maksymalne obciążenie trenera nóg / Maximum weights on leg developer / Maximální zatížení předkopávání	-	-	45 kg	45 kg
Maksymalne obciążenie wyciągu górnego / Maximum weights on cross-over, lat pull / Maximální zatížení přitahy vrchních úchyty	90 kg	90 kg	90 kg	90 kg
Rodzaj obciążenia / Type of load / Druh zátěže	Dwa stosy obciążeniowe po 90 kg regulowane co 6 kg+wolny ciężar/ Two 90 kg stacks adjusted every 6 kg+free weight / Dva štosy závaží 90 kg, nastavitelné co 6 kg+ jednotlivých hmotností	Wolny ciężar / Free weight / Jednotlivých hmotností	Wolny ciężar / Free weight / Jednotlivých hmotností	Wolny ciężar / Free weight / Jednotlivých hmotností
Maksymalna waga użytkownika / Maximum user weight / Maximální uživatelská hmotnost	160 kg	160 kg	135 kg	135 kg
Wymiary produktu / Product dimensions / Rozměry výrobku	193,8 x 151,6 x 216,7 cm	199 x 150 x 220 cm	242 x 205 x 219 cm	227 x 202 x 205 cm
Waga netto / brutto / Weight netto/brutto / Hmotnost produktu netto/brutto	369,5/388,5 kg	139,5/152 kg	164/165 kg	96/97 kg
Wymiary opakowania / Packing dimensions / Rozměry balení	212 x 43 x 15,5 cm 156 x 46,5 x 22 cm 127 x 55 x 19 cm 72 x 55 x 14 cm 37,5 x 24 x 12,5 cm 37,5 x 24 x 12,5 cm 37,5 x 24 x 12,5 cm 37,5 x 24 x 12,5 cm 9,2 x 193,5 cm	212 x 43 x 16,5 cm 142 x 57 x 21 cm 133 x 46 x 21 cm	199 x 50,2 x 19 cm 112 x 54 x 20 cm 154 x 61,5 x 17 cm	199 x 42 x 18 cm 137,5 x 63 x 20 cm
Ilość w kontenerze 20'/40'/40HQ / Q-ty in container 20'/40'/40HQ / Množství v kontejneru 20'/40'/40HQ	45/53	50/120/150	51/95/110	75/150/162





Tytan 15



Home gym
17-50-015





Tytan 10R



Home gym
17-50-010



Cyborg 1



Home gym
17-50-001





Tytan 9



Home gym
17-50-009



Tytan 12



Home gym
17-50-012





Tytan 7



Home gym
17-50-007



Tytan 23



Home gym
17-50-023





Model / Model / Třída	TYTAN 15	TYTAN 10R	CYBORG 1	TYTAN 9	TYTAN 12	TYTAN 7	TYTAN 23
	Atlas / Home gym / Posilovací věž	Atlas / Home gym / Posilovací věž	Atlas / Home gym / Posilovací věž	Atlas / Home gym / Posilovací věž	Atlas / Home gym / Posilovací věž	Atlas / Home gym / Posilovací věž	Atlas / Home gym / Posilovací věž
	Atlas do treningu siłowo-wytrzymałościowego całego ciała / Home gym for strength training of whole body / Věž pro silový trénink celého těla	Atlas do treningu siłowo-wytrzymałościowego całego ciała / Home gym for strength training of whole body / Věž pro silový trénink celého těla	Atlas do treningu siłowo-wytrzymałościowego całego ciała / Home gym for strength training of whole body / Věž pro silový trénink celého těla	Atlas do treningu siłowo-wytrzymałościowego całego ciała / Home gym for strength training of whole body / Věž pro silový trénink celého těla	Atlas do treningu siłowo-wytrzymałościowego całego ciała / Home gym for strength training of whole body / Věž pro silový trénink celého těla	Atlas do treningu siłowo-wytrzymałościowego całego ciała / Home gym for strength training of whole body / Věž pro silový trénink celého těla	Atlas do treningu siłowo-wytrzymałościowego całego ciała / Home gym for strength training of whole body / Věž pro silový trénink celého těla
Rodzaj obciążenia / Type of load / Druh zátěže	Dwa stopy obciążeniowe po 66,2kg regulowane co 5,6kg+wolny ciężar / Two 66,2 kg stacks adjusted every 5,6 kg+free weight / Dva štosy závaží 66,2kg, nastavitelné co 5,6kg+jednotlivých hmotností	Stos obciążeniowy 90,72 kg+wolny ciężar / Stack 90,72 kg+free weight / Stack 90,72 kg+ednotlivých hmotností	Wolny ciężar / Free weight / Jednotlivých hmotností	Stos obciążeniowy 67,5 kg+wolny ciężar / Stack 67,5 kg+free weight / Stack 67,5 kg+ednotlivých hmotností	Stos obciążeniowy 68 kg / Stack 68 kg / Stack 68 kg	Stos obciążeniowy 67,5 kg / Stack 67,5 kg / Stack 67,5 kg	Wolny ciężar / Free weight / Jednotlivých hmotností
Maksymalne obciążenie trenážera nóg / Maximum weights on leg developer / Maximální zatížení předkopávání	66,2 kg	90,72 kg	45 kg	67,5 kg	68 kg	67,5 kg	45 kg
Maksymalne obciążenie wyciągu górnego / Maximum weights on cross-over, lat pull / Maximální zatížení přitahy vrchních úchyty	66,2 kg	90,72 kg	90 kg	67,5 kg	68 kg	67,5 kg	45 kg
Maksymalna waga użytkownika / Maximum user weight / Maximální uživatelská hmotnost	140 kg	140 kg	135 kg	100 kg	100 kg	100 kg	100 kg
Wymiary produktu / Product dimensions / Rozměry výrobku	223 x 248 x 355 cm	270 x 203 x 141 cm	222 x 206 x 157 cm	165 x 205 x 118 cm	160 x 212 x 225 cm	151 x 205 x 116 cm	140,5 x 153-222 x 68-163 cm
Waga netto / brutto / Weight netto/brutto / Hmotnost produktu netto/brutto	371/398 kg	188 / 203 kg	69 / 72 kg	142 / 152 kg	142,5/145 kg	138 / 151 kg	40 / 42 kg
Wymiary opakowania / Packing dimensions / Rozměry balení	190 x 43 x 14 cm 133 x 27,5 x 17 cm 105 x 108 x 25 cm 77 x 33 x 29 cm 185 x 27,5 x 20,5 cm 79 x 40 x 25 cm 192 x 27,5 x 20 cm 188 x 91 x 24 cm 67 x 45 x 23 cm 124 x 39 x 15 cm 136 x 23 x 36 cm 39 x 20 x 19 cm 39 x 20 x 19 cm 39 x 20 x 19 cm 39 x 20 x 19 cm 39 x 20 x 23 cm	199 x 31 x 21,5 cm 107 x 98 x 8 cm 150,5 x 59 x 18 cm 188 x 26 x 10,6 cm 39 x 19 x 19,5 cm 39,5 x 19 x 23 cm 39,5 x 19 x 23 cm 39,5 x 19 x 23 cm	199 x 45,5 x 20 cm 123 x 63 x 18 cm 55 x 37 x 13 cm	19,2 x 38 x 25 cm 11,8 x 40 x 43 cm 72,5 x 43 x 26,5 cm 39 x 19 x 18 cm 39 x 19 x 18 cm 39 x 19 x 18 cm	19,5 x 39,5 x 14 cm 13,5 x 51 x 23,5 cm 38,5 x 20 x 23 cm 40 x 20 x 27 cm	180 x 23 x 26 cm 136 x 47 x 18 cm 90 x 44 x 24 cm 17,5 x 28 x 20,5 cm 38 x 19 x 18,5 cm 38 x 19 x 18,5 cm 38 x 18,5 x 23 cm	156 x 36 x 12,5 cm 87 x 29,5 x 34 cm
Ilość w kontenerze 20'/40'/40HQ / Q-ty in container 20'/40'/40HQ / Množství v kontejneru 20'/40'/40HQ	61	58/108	80/150/162	55/143	84/153/170	65/139	195/390/450



UW15



Long lat bar
17-62-165



UW14



Long lat bar
17-62-164



UW16



Long lat bar
17-62-166



UW13



Long lat bar
17-62-163



UW17 / UW11



Curl lat bar

17-62-167 UW17 (42x21 cm)
17-62-161 UW11 (36x18 cm)



UW10 / UW08



Double lat pull bar

17-62-160 UW10 (47x24 cm)
17-62-158 UW08 (31x17 cm)



UW06



V-shaped bar

17-62-156

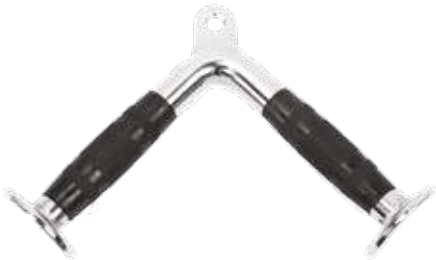

UW04



Double row handle

17-62-154



UW05



Double row handle

17-62-155

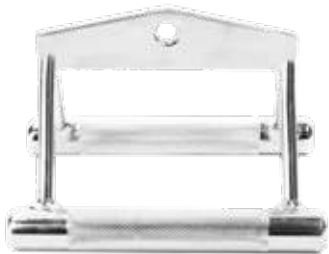

UW12



Straight lat bar

17-62-162





UW01



Single row handle
17-62-151



UW03



Single row handle
17-62-153



UW09



Double tricep rope
17-62-159



UW07



Single tricep rope
17-62-157



UWC31



Single row handle
17-62-181





Model / Model / Třída	UW15	UW14	UW16	UW13	UW11	UW17	UW08	UW10	UW06
	Uchwyt średni łamany	Uchwyt prosty długi	Uchwyt równoległy długi	Uchwyt falowany	Uchwyt łamany	Uchwyt łamany	Uchwyt podwójny średni	Uchwyt podwójny szeroki	Uchwyt trójkątny
Obrotowy uchwyt zaczepowy / Swivel hook / Otočný hák	•	•	•	•	•	•	-	•	-
Materiał / Material / Materiál	Stal chromowana, guma / Chromed steel, rubber / Pochromovaná ocel, guma	Stal chromowana, guma / Chromed steel, rubber / Pochromovaná ocel, guma	Stal chromowana / Chromed steel / Pochromovaná ocel	Stal chromowana, guma / Chromed steel, rubber / Pochromovaná ocel, guma	Stal chromowana, guma / Chromed steel, rubber / Pochromovaná ocel, guma	Stal chromowana, guma / Chromed steel, rubber / Pochromovaná ocel, guma	Stal chromowana / Chromed steel / Pochromovaná ocel	Stal chromowana / Chromed steel / Pochromovaná ocel	Stal chromowana, guma / Chromed steel, rubber / Pochromovaná ocel, guma
Długość / Length / Délka	89,5 cm	121,5 cm	85 cm	77 cm	41 cm	35 cm	30,5 cm	48 cm	38 cm
Rozstaw rękojeści / Spacing of the handle / Rozestup rukojeti	88 cm	110 cm	83 cm	65 cm	40 cm	35 cm	28,5 cm	45 cm	28 cm
Średnica uchwytu / Handle diameter / Průměr rukojeti	3,2 cm	3,2 cm	2,5 cm	3,5 cm	3,2 cm	3,2 cm	2,5 cm	2,5 cm	3,5 cm

Model / Model / Třída	UW04	UW05	UW12	UW01	UW03	UW09	UW07	UWC31
	Uchwyt podwójny wąski	Uchwyt podwójny wąski	Uchwyt krótki prosty	Uchwyt pojedynczy	Uchwyt pojedynczy	Podwójny sznur do wyciągu	Pojedynczy sznur do wyciągu	Pojedynczy uchwyt piankowy
Obrotowy uchwyt zaczepowy / Swivel hook / Otočný hák	-	-	•	-	-	•	-	-
Materiał / Material / Materiál	Stal chromowana, guma / Chromed steel, rubber / Pochromovaná ocel, guma	Stal chromowana / Chromed steel / Pochromovaná ocel	Stal chromowana, guma / Chromed steel, rubber / Pochromovaná ocel, guma	Stal chromowana, guma / Chromed steel, rubber / Pochromovaná ocel, guma	Stal chromowana / Chromed steel / Pochromovaná ocel	Nylon, tworzywo sztuczne / Nylon, plastic / Nylon, plastický	Nylon, tworzywo sztuczne / Nylon, plastic / Nylon, plastický	NBR, pianka / NBR, foam / NBR, pěna
Długość / Length / Délka	18 cm	19 cm	52 cm	15,5 cm	14 cm	70 cm	30 cm	20 cm
Rozstaw rękojeści / Spacing of the handle / Rozestup rukojeti	17,5 cm	17 cm	52 cm	-	-	-	-	-
Średnica uchwytu / Handle diameter / Průměr rukojeti	3,5 cm	3,5 cm	3,2 cm	3,5 cm	3 cm	2,5/6,5 cm	2,5/6,5 cm	3,5 cm





PWL9569



Multifunctional
pull up bench
17-53-500





LS3859



Barbell bench
17-53-400



LS5730W



Barbell bench
17-53-401





LS7849



Barbell bench
17-53-300



Maximum
load weight
110 kg

LS7838



Barbell bench
17-53-301



Maximum
load weight
100 kg



LS3050



Exercise bench
17-53-302



Maximum
load weight
135 kg

L8011



Exercise bench
17-53-000



Maximum
load weight
150 kg



L8015



Exercise bench
17-53-202



L8301



Exercise bench with ropes
17-53-201





L8320



Multifunctional exercise bench

17-53-200



Maximum
load capacity
110 kg

L8355



Incline bench with dumbbells and ropes

17-53-100



Maximum
load capacity
100 kg



Model / Model / Třída	PWL 9569	LS3859	LS5730W	LS7849	LS7838	LS3050	L8011	L8015	L8301	L8320	L8355
	Poręcz wielofunkcyjna z ławką / Multifunctional pull up bench / Multifunkční posilovací stroj s lavicí	Ławka pod sztangę / Barbell bench / Lavička pod činku	Ławka do ćwiczeń / Barbell bench / Lavička pod činku	Ławka do ćwiczeń / Barbell bench / Posilovací lavice	Ławka do ćwiczeń / Barbell bench / Posilovací lavice	Ławka do ćwiczeń / Exercise bench / Posilovací lavice	Ławka do ćwiczeń / Exercise bench / Posilovací lavice	Ławka do ćwiczeń / Exercise bench / Posilovací lavice	Ławka do ćwiczeń z linkami / Exercise bench with ropes / Posilovací lavice s činkami	Wielofunkcyjna ławka do ćwiczeń / Multifunctional exercise bench / Multifunkční lavice	Ławka skośna do ćwiczeń z linkami i ciężarkami / Incline bench with dumbbells and ropes / Šikma lavicka s činkami a gumowymi lanky
Maksymalne obciążenie / Maximum load / Maximální zatížení	120 kg	270 kg	270 kg	150 kg	110 kg	240 kg	240 kg	240 kg	100 kg	110 kg	110 kg
Maksymalne obciążenie na stojak / Maximum drop weight / Maximální zatížení stojanu	100 kg	135 kg	135 kg	100 kg	50 kg	-	-	-	-	-	-
Maksymalne obciążenie na prasę do nóg / Maximum load on leg press station / Maximální zatížení nožní části	-	45 kg	45 kg	30 kg	30 kg	45 kg	-	-	-	-	-
Maksymalna waga użytkownika / Maximum user weight / Maximální uživatelská hmotnost	120 kg	135 kg	135 kg	110 kg	100 kg	135 kg	150 kg	150 kg	100 kg	110 kg	100 kg
Wymiary produktu / Product dimensions / Rozměry výrobku	205 x 120 x 229 cm	164 x 110 x 165 cm	164 x 110 x 165 cm	168 x 118 x 137,5 cm	158 x 113 x 147 cm	183 x 69 x 85 cm	114 x 38 x 47 cm	128 x 52 x 115 cm	151 x 32 x 118 cm	155 x 44 x 130 cm	135 x 58 x 65 cm
Waga netto / brutto / Weight netto/brutto / Hmotnost produktu netto/brutto	31,5 / 32,5 kg	40,5 / 43,5 kg	42 / 48,5 kg	23 / 25,5 kg	22 / 24 kg	35,5 / 39 kg	8 / 10 kg	17 / 18,5 kg	12 / 13 kg	12,4 / 13,5 kg	12 / 14 kg
Wymiary opakowania / Packing dimensions / Rozměry balení	136 x 53 x 19 cm	129 x 57 x 21,5 cm	101 x 40 x 15 cm 114 x 54,5 x 25 cm	123 x 52 x 17 cm	116 x 46 x 15 cm	153 x 61,5 x 18 cm	118 x 37 x 22 cm	117 x 44,5 x 19 cm	122 x 17 x 32,5 cm	128,5 x 34 x 23 cm	116 x 36 x 18 cm
Ilość w kontenerze 20'/40'/40HQ / Q-ty in container 20'/40'/40HQ / Množství v kontejneru 20'/40'/40HQ	130/270/320	176/352/384	135/270/328	250/510/625	325/655/796	164/320/400	300/600/700	300/600/700	415/830/1008	273/547/664	374/748/909



S8004



Twist stepper with column
and ropes
17-22-001





S3096



Twist stepper with sticks

17-22-109



S3085



Twist stepper with sticks

17-22-106 PINK-WHITE
17-22-107 GREEN-WHITE





S3088



2in1 stepper (straight/twist)

17-22-050



S3033



Twist stepper

17-22-104 PINK-WHITE
17-22-103 GREEN-WHITE



S3092



Stepper

17-22-153



S3038



Stepper

17-22-150



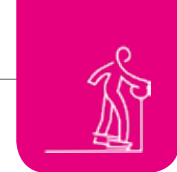

Model / Model / Třída	S8004	S3096	S3085	S3088	S3033	S3092	S3038
	Stepper skrętny z kolumną i linkami / Twister stepper with column and rope / Stepper s bočním nášlapem se sloupkem a lanky	Stepper skośny z drążkami / Twist stepper with sticks / Stepper s bočním nášlapem s rukojeťmi	Stepper skośny z drążkami / Twist stepper with sticks / Stepper s bočním nášlapem s rukojeťmi	Stepper 2w1 (prosty/skrętny) z linkami / 2in1 stepper (straight/twist) with ropes / Stepper 2v1 (s horním nášlapem / s bočním nášlapem) s lanky	Stepper skośny / Twist stepper / Stepper s bočním nášlapem	Steper / Stepper	Steper / Stepper
Kolor / Colour / Barva	Zielony / Green / Zelená	Zielony / Green / Zelená	Zielony, Różowy / Green, Pink / Zelená, Růžový	Zielony / Green / Zelená	Zielony, Różowy / Green, Pink / Zelená, Růžový	Pomarańczowy / Orange / Oranżový	Biało-czarny / White-black / Bílo-černý
Ekspandery do ćwiczeń / Exercise expanders / Cvičební expandéry	•	•	•	•	•	•	•
Cylindry / Cylinders / Cylindry	Hydrauliczne 2 szt. / Hydraulic 2pcs. / Hydraulické 2 ks.	Hydrauliczne 2 szt. / Hydraulic 2pcs. / Hydraulické 2 ks.	Hydrauliczne 2 szt. / Hydraulic 2pcs. / Hydraulické 2 ks.	Hydrauliczne 2 szt. / Hydraulic 2pcs. / Hydraulické 2 ks.	Hydrauliczne 2 szt. / Hydraulic 2pcs. / Hydraulické 2 ks.	Hydrauliczne 2 szt. / Hydraulic 2pcs. / Hydraulické 2 ks.	Hydrauliczne 2 szt. / Hydraulic 2pcs. / Hydraulické 2 ks.
Funkcje komputera / Computer Functions / Funkce počítače	Czas, liczba powtórzeń, liczba powtórzeń na minutę, kalorie, skan / Time, step counter, number of repetitions per minute, calories, scan / Čas, počítadlo kroku, počet opakování za minutu, spálené kalorie, scan	Czas, liczba powtórzeń, liczba powtórzeń na minutę, kalorie, skan / Time, step counter, number of repetitions per minute, calories, scan / Čas, počítadlo kroku, počet opakování za minutu, spálené kalorie, scan	Czas, liczba powtórzeń, liczba powtórzeń na minutę, kalorie, skan / Time, step counter, number of repetitions per minute, calories, scan / Čas, počítadlo kroku, počet opakování za minutu, spálené kalorie, scan	Czas, liczba powtórzeń, liczba powtórzeń na minutę, kalorie, skan / Time, step counter, number of repetitions per minute, calories, scan / Čas, počítadlo kroku, počet opakování za minutu, spálené kalorie, scan	Czas, liczba powtórzeń, liczba powtórzeń na minutę, kalorie, skan / Time, step counter, number of repetitions per minute, calories, scan / Čas, počítadlo kroku, počet opakování za minutu, spálené kalorie, scan	Czas, liczba powtórzeń, liczba powtórzeń na minutę, kalorie, skan / Time, step counter, number of repetitions per minute, calories, scan / Čas, počítadlo kroku, počet opakování za minutu, spálené kalorie, scan	"Czas, liczba powtórzeń, liczba powtórzeń na minutę, kalorie, skan / Time, step counter, number of repetitions per minute, calories, scan / Čas, počítadlo kroku, počet opakování za minutu, spálené kalorie, scan "
Wymiary produktu / Item size / Rozměry produktu	40 x 43 x 101 - 113 cm	41,5 x 46 x 102-138 cm	40 x 46 x 137 cm	45 x 48 x 24 cm	40,5 x 39 x 20 cm	43 x 32,5 x 23 cm	36 x 31,5 x 20 cm
Regulowana wysokość kolumny (za pomocą pokrętki) / Adjustable column height (by the knob) / Nastavitelná výška sloupku (pomocí regulačního šroubu)	6 stopni regulacji (co 2,4 cm): 101-113 cm / 6 levels (every 2,4 cm): 101-113 cm / 6 stupňů nastavení (každých 2,4 cm): 101-103 cm	-	-	-	-	-	-
Waga netto/brutto / Weight netto/brutto / Hmotnost produktu netto/brutto	10 / 11 kg	8 / 9 kg	9,5 / 10,2 kg	11 / 12,5 kg	7 / 8,5 kg	7,3 / 8,3 kg	5,4 / 6,5 kg
Maksymalna waga użytkownika / Maximum user weight / Maximální užívatelská hmotnost	100 kg	100 kg	100 kg	100 kg	100 kg	100 kg	100 kg
Wymiary opakowania / Packing dimensions / Rozměry balení	43 x 35 x 51 cm	46 x 24 x 51 cm	45 x 23 x 52 cm	53 x 30 x 49,5 cm	46 x 42 x 23 cm	35 x 24 x 45 cm	35 x 25 x 43 cm



AS007



Aerobic step
17-44-023





AS006



Aerobic step
17-44-020



AS005



Aerobic step

- 17-44-016 GRAY-BLACK
- 17-44-015 BLACK-RED
- 17-44-017 WHITE-BLUE



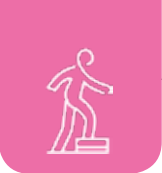

AS004



Aerobic step

- 17-44-013 BLUE-LIGHT BLUE
- 17-44-012 BLUE-GRAY



AS003



Aerobic step

- 17-44-008 BLACK-GRAY-RED
- 17-44-010 GRAY-GREEN





Model / Model / Třída	S8004	S3096	S3085	S3088	S3033
	Step do aerobiku / Aerobic step / Step na aerobic	Step do aerobiku / Aerobic step / Step na aerobic	Step do aerobiku / Aerobic step / Step na aerobic	Step do aerobiku / Aerobic step / Step na aerobic	Step do aerobiku / Aerobic step / Step na aerobic
Kolor / Colour / Barva	czarno - pomarańczowy / Black - orange / Černá-oranžový	zielono - fioletowy / green - purple / Zelená-fialový	czarno-czerwony, szaro - czarny, biało - niebieski / Black-red, gray-black, white-blue / Černá-červená, šedá-černá, bílá-modrý	czarny, niebieski / Black, blue / Černá, modrý	czarno - czerwony, niebiesko - żółty, zielono - szary / Black-red, blue-yellow, green-gray / Černá-červená, modrý-žlutý, zelená-šedá
Materiał / Material / Materiál	PP	PE	PP	PP	PP
Regulacja wysokości / Height adjustment / Nastavení výšky	Trzystopniowa / 3-step adjustment / Třístupňová regulace	Trzystopniowa / 3-step adjustment / Třístupňová regulace	Trzystopniowa / 3-step adjustment / Třístupňová regulace	Trzystopniowa / 3-step adjustment / Třístupňová regulace	Dwustopniowa / 2-step adjustment / Třístupňová regulace
Zakres regulacji wysokości / height adjustment range / Rozsah nastavení výšky	15 / 20 / 25 cm	10 / 15 / 20 cm	15 / 20 / 25 cm	10 / 15 / 20 cm	10 / 15 cm
Długość / Length / Délka	100 cm	108 cm	90 cm	80 cm	67 cm
Szerokość / Width / Šířka	37,5 cm	41,5 cm	32 cm	31 cm	27 cm
Maksymalna waga użytkownika / Maximum user weight / Maximální uživatelská hmotnost	300 kg	300 kg	250 kg	250 kg	150 kg
Waga netto/brutto / Weight netto/brutto / Hmotnost produktu netto/brutto	7,5 / 8 kg	9 / 9,5 kg	5,1 / 5,5 kg	4 / 4,5 kg	2,5 / 2,9 kg
Wymiary opakowania / Packing dimensions / Rozměry balení	108 x 40 x 17 cm	118 x 45,5 x 12 cm	92 x 34 x 64 cm	80,5 x 31 x 11 cm	71 x 28,5 x 11 cm





YM09



Folding exercise mat

17-44-140





MFK04



Heated club mat

17-44-290 DARK GREY-BLACK



MFK01



Club mat

17-44-271 GREEN-BLACK
17-44-270 VIOLET- BLACK
17-44-272 ORANGE-BLACK

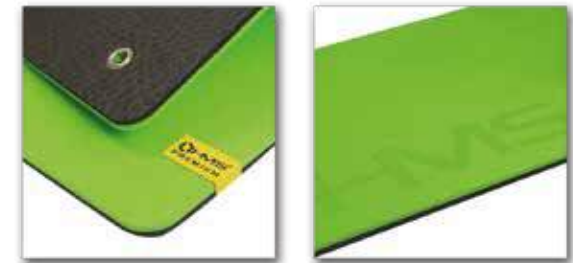

MFK02



Club mat

17-44-273 BLUE-BLACK
17-44-275 GREY-BLACK
17-44-274 PINK-BLACK

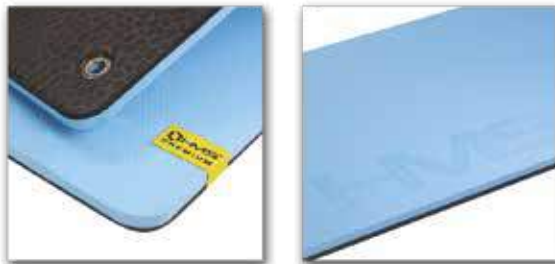

MFK03



Club mat

17-44-278 RED-BLACK
17-44-279 BLUE- BLACK
17-44-280 GREEN-BLACK







YM06T



Yoga mat with bag

- 17-44-147 GREEN-BLACK
- 17-44-146 BLUE-BLACK



YM06



Yoga mat

- 17-44-141 PINK-BLACK
- 17-44-142 BLUE-BLACK
- 17-44-143 GREEN-BLACK



YM05



Yoga mat

- 17-44-145 VIOLET-BLACK
- 17-44-144 BREEN-BLACK

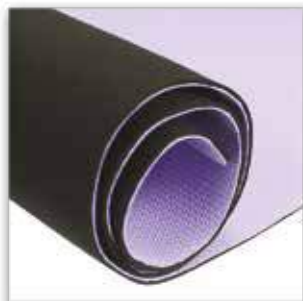
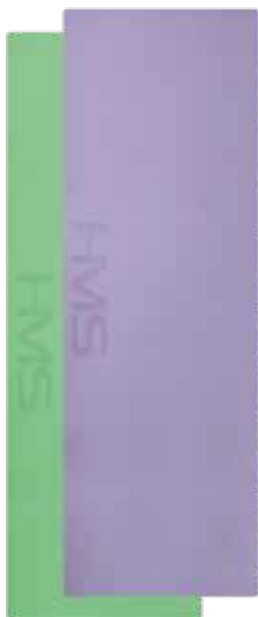

YM04



Yoga mat

- 17-44-131 PINK
- 17-44-130 MINT





YM03



Yoga mat

- 17-44-120 GRAY
- 17-44-121 BLUE



YM02



Yoga mat

- 17-44-112 PINK
- 17-44-110 GREEN
- 17-44-113 BLACK
- 17-44-111 ORANGE



YM01



Yoga mat

- 17-44-200 TURQUOISE
- 17-44-102 PINK
- 17-44-201 PURPLE
- 17-44-200 BLUE



MP12

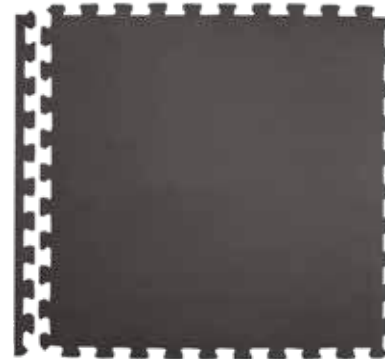

Puzzle mat

17-63-018

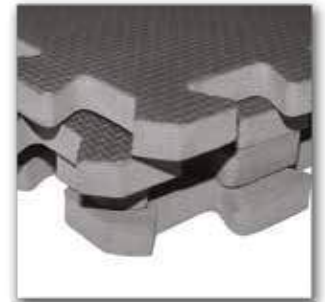
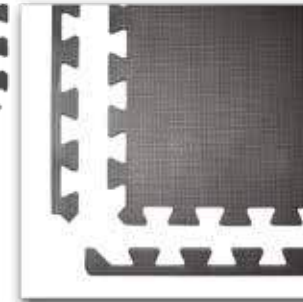



Model / Model / Třída	YM09	MFK04	MFK01	MFK02	MFK03	YM06T	YM06	YM05	YM04	YM03	YM02	YM01	MP12
	Mata składana do ćwiczeń / Folding exercise mat / Składací podložka pro cvičení	Mata klubowa zgrzewana / Heated club mat / Klubová podložka, svařovaná	Mata klubowa / Club mat / Klubová podložka	Mata klubowa / Club mat / Klubová podložka	Mata klubowa / Club mat / Klubová podložka	Mata do jogi / Yoga Mat / Jóga podložka	Mata do jogi / Yoga Mat / Jóga podložka	Mata do jogi / Yoga Mat / Jóga podložka	Mata do jogi / Yoga Mat / Jóga podložka	Mata do jogi / Yoga Mat / Jóga podložka	Mata do jogi / Yoga Mat / Jóga podložka	Mata do jogi / Yoga Mat / Jóga podložka	Mata puzzle pod sprzęt siłowy / Puzzle mat / Puzzle podložka pod fitness vybavení
Materiał / Material / Materiál	Wewnętrzny EPE, zewnętrzny PU skóra / Inner EPE, outer PU leather / Vnitřní EPE, vnější PU kůže	Laminowana i zgrzewana pianka, powłoka PVC / Heated, laminated foam, PVC cover / Laminovaná a svařovaná pěna, povrch: PVC	TPE, EVA	TPE, EVA	TPE, EVA	TPE	TPE	TPE	NBR	NBR	PVC	PVC	EVA
Torba / Bag / Taška	-	-	-	-	-	•	-	-	-	-	-	-	-
Długość, szerokość / Length, width / Délka, šířka	71 x 30 cm	100 x 50 cm	110 x 55 cm	120 x 60 cm	180 x 60 cm	180 x 60 cm	180 x 60 cm	180 x 60 cm	183 x 61 cm	183 x 61 cm	173 x 61 cm	173,5 x 61 cm	-
Wymiary jednego elementu / Dimensions of a single element / Rozměr jednoho elementu	-	-	-	-	-	-	-	-	-	-	-	-	61 x 61 x 1,2 cm
Wymiary po złożeniu 4 elementów / Dimensions of the 4 elements combined / Rozměr po složení 4 elementů	-	-	-	-	-	-	-	-	-	-	-	-	122 x 122 x 1,2 cm
Grubość / Thickness / Tloušťka	25 / 90 mm	10 mm	15 mm (TPE 10 mm, EVA 5 mm)	20 mm (TPE 13 mm, EVA 7 mm)	15 mm (TPE 10 mm, EVA 5 mm)	8 mm	8 mm	8 mm	15 mm	10 mm	6 mm	3 mm	12 mm
Wymiary opakowania / Packaging dimensions / Rozměry balení	30 x 36 x 9 cm	100 x 50 cm	110 x 55 cm	120 x 60 cm	180 x 60 cm	60 x 16 cm	60 x 16 cm	60 x 16 cm	61 x 15,5 x 15,5 cm	61 x 15,5 x 15,5 cm	61 x 11,5 x 11,5 cm	61 x 8,5 x 8,5 cm	63 x 63 x 5 cm
Ilość w opakowaniu zbiorczym / Multipacking / Počet w velkoobchodního balení	10	10	20	20 / 25	20	16	16	30	6	10	10	10	10
Wymiary opakowania zbiorczego / Multipack dimensions / Rozměry velkoobchodního balení	91 x 39 x 32 cm	103 x 53 x 14 cm	112 x 32 x 57 cm	121 x 62 x 53 cm / 121 x 62 x 42 cm	182 x 62 x 32 cm	129 x 62 x 34 cm	129 x 62 x 34 cm	129 x 62 x 34 cm	60 x 40 x 63 cm	84 x 34,5 x 63 cm	48,5 x 20 x 63 cm	48,5 x 20 x 63 cm	65 x 65 x 56 cm
Waga opakowania zbiorczego / Multipack weight / Hmotnost velkoobchodního balení	6,6 / 7,6 kg	13,9 / 15,75 kg	17,9 / 19,3 kg	29,2 / 30,7 kg / 34,2 / 35,7 kg	32 / 34 kg	17,3 / 19,3 kg	14 / 16 kg	16 / 18 kg	10 kg	10 kg	10 kg	10,3 kg	16 kg
Waga netto, brutto / Weight netto, brutto / Hmotnost produktu netto, brutto	0,66 kg	1,27 / 1,30 kg	0,82 / 0,9 kg	1,38 / 1,45 kg	1,48 / 1,53 kg	0,9 / ,98 kg	0,9 / 0,93 kg	0,45 / 0,49 kg	0,9/0,91 kg	0,9/0,91 kg	1,24/1,25 kg	0,825/0,83 kg	1,4/1,41 kg





YB03



Gym ball

- 17-42-134 75 CM DARK GRAY
- 17-42-133 65 CM GRAY
- 17-42-132 65 CM LIGHT GRAY
- 17-42-130 55 CM PURPLE
- 17-42-131 55 CM NAVY BLUE



YB02



Gym ball

- 17-42-125 75 CM STEEL
- 17-42-120 65 CM PURPLE
- 17-42-122 65 CM BLACK
- 17-42-121 65 CM GRIZZLY
- 17-42-116 55 CM GRAPHITE
- 17-42-115 55 CM ORANGE





YB01



Gym ball

- 17-42-110 75 CM BLUE
- 17-42-106 65 CM GREEN
- 17-42-107 65 CM RED
- 17-42-105 65 CM BLUE
- 17-42-101 55 CM PINK
- 17-42-100 55 CM BLUE



BSX10



Balance ball

17-42-300





BSX PRO



Balance ball

17-42-303



PLAB1



Balance board

17-42-302



PS01



Balance cushion

17-42-301





KJ01

HMS®

Yoga block

17-44-250 BLUE
17-44-251 PURPLE

Model / Model / Třída	YB03	YB02	YB01
	Piłka gimnastyczna / Gym ball / Gymnastický míč	Piłka gimnastyczna / Gym ball / Gymnastický míč	Piłka gimnastyczna / Gym ball / Gymnastický míč
Anti - burst	•	•	-
Antypoślizgowa / Non - slip / Antiskluzová	•	•	•
Pompka / Pump / Hustilka	•	•	•
Ekspandery do ćwiczeń / Exercise expanders / Cvičební expandéry	-	-	-
Materiał powłoki / Coating material / Svrchní materiál	PVC	PVC	PVC
Materiał podstawy / Base material / Materiál základny	-	-	-
Średnica / Diameter / Průměr	55 cm / 65 cm / 75 cm	55 cm / 65 cm / 75 cm	55 cm / 65 cm / 75 cm
Wymiary / Dimension / Rozměry	-	-	-
Maksymalne obciążenie / Maximum load / Maximální zatížení	250 kg	100 kg	100 kg
Twardość / Hardness / Tvrdost	-	-	-
Waga netto/brutto / Weight netto/brutto / Hmotnost produktu netto/brutto	0,85 kg / 0,988 kg (55 cm) / 0,968 kg / 1,106 kg (65 cm) / 1,18 kg / 1,318 kg (75 cm)	0,85 kg / 0,988 kg (55 cm) / 0,968 kg / 1,106 kg (65 cm) / 1,18 kg / 1,318 kg (75 cm)	"0,848 kg / 0,986 kg (55 cm) / 1,01 kg / 1,148 kg (65 cm) / 1,195 kg / 1,333 kg (75 cm) "
Wymiary opakowania / Packaging dimensions / Rozměry balení	26 cm x 18 cm x 11,2 cm	26 cm x 18 cm x 11,2 cm	26 cm x 18 cm x 11,2 cm
Ilość w opakowaniu zbiorczym / Multipacking / Počet w veľkoobchodního balení	8	10	10
Wymiary opakowania zbiorczego / Multipack dimensions / Rozměry veľkoobchodního balení	56,5 x 28 x 38,5 cm	52 x 27,5 x 44 cm	52 x 27,5 x 44 cm
Waga opakowania zbiorczego / Multipack weight / Hmotnost veľkoobchodního balení	10/ 11/ 12,5 kg	10/ 12/ 14 kg	10/ 12/ 14 kg



BSX10	BSX PRO	PLAB1	PS01	KJ01
Piłka do balansowania / Balance ball / Modry bosu mič	Piłka do balansowania / Balance ball / Modry bosu mič	Platforma do balansowania / Balance board / Balanční desky	Poduszka sensomotoryczna / Balance cushion / Balanční čochka	Klocki do jogi / Yoga block / Jóga bloky
•	•	-	-	-
•	•	-	-	-
•	•	-	-	-
-	-	-	-	-
PVC	PVC	PP	PP	EVA
ABS	ABS	Cement, piasek / Cement,sand/ Cement, písek	-	-
60 cm	63 cm	40 cm	35 cm	-
-	-	-	-	10 cm x 15 cm x 22 cm
250 kg	250 kg	200 kg	150 kg	-
-	-	-	-	55
5 kg / 6 kg	7 kg / 8 kg	1,5 kg / 1,7 kg	1,1 kg / 1,2 kg	0,09 kg / 0,1 kg
60 cm x 60 cm x 12 cm	68 x 68 x 12 cm	42 x 42 x 12 cm	36 cm x 36 cm x 6,5 cm	-
2	2	1	10	20
61,5 x 24,5 x 62 cm	69 x 69 x 25 cm	42 x 42 x 12 cm	67 cm x 37,5 cm x 37,5 cm	47 x 32 x 52 cm
13,6 kg	17,3 kg	1,7 kg	13 kg	3,5/ 4,3 kg







FSV300



Vibration roller

17-39-050

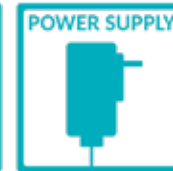

FSBM01



Massage set

17-39-100





FS109



Roller

- 17-39-029 BLUE
- 17-39-028 BLACK
- 17-39-030 ORANGE



FS107



Roller

- 17-39-023 PURPLE
- 17-39-021 BLACK
- 17-39-022 BLUE



FS115



Roller

- 17-39-044 BLACK/BLUE- YELLOW DOTS
- 17-39-045 BLACK/RED DOTS



FS114



Roller

- 17-39-043 BLACK/BLUE DOTS
- 17-39-042 BLACK/GREEN-ORANGE DOTS



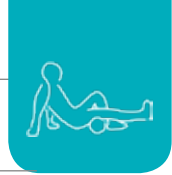

FS112



Two part twisted roller

- 17-39-039 RED
- 17-39-038 GRAY



FS104



Roller

- 17-39-014 BLUE
- 17-39-013 BLACK
- 17-39-015 RED



FS102



Roller

- 17-39-006 GREEN
- 17-39-005 BLACK



FS103



Roller

- 17-39-007 RED
- 17-39-008 GREEN
- 17-39-011 PURPLE
- 17-39-010 BLUE
- 17-39-009 BLACK





FS113



Roller 2 in 1
17-39-041



FS105



Roller 3 in 1
17-39-017



FS111



Roller
17-39-035 BLACK/YELLOW
17-39-036 GRAPHITE/BLACK



FS101



Roller
17-39-003 PINK
17-39-001 GREEN
17-39-002 ORANGE





FS110



Roller

- 17-39-032 BLACK
- 17-39-033 ORANGE



FS108



Roller

- 17-39-025 GREEN-BLACK
- 17-39-026 RED-WHITE



FS201



Roller

- 17-39-047 BLACK
- 17-39-048 GREEN
- 17-39-049 BLUE



FS106



Roller

- 17-39-019





FS202



Roller
17-39-060 BLACK



FS116



Roller
17-39-046 BLACK



BLC01/BLC02



Silicone massage ball

- 17-42-001 BLC01
- 17-42-002 BLC02



BLM01/BLM02



EPP massage ball

- 17-42-022 BLM01 10 CM
- 17-42-021 BLM01 8 CM
- 17-42-020 BLM01 6 CM
- 17-42-023 BLM02 12x24 CM
- 17-42-024 BLM02 8x16 CM



Model / Model / Třída	FSV300	FSBM01 (FS202, BLM01, FS116, BLM02)	FS109	FS107	FS115	FS114	FS112	FS104	FS102	FS103	FS113	FS105	
	Wibrujący walek fitness/ roller / Vibration roller / Roller vybavena akumulátorem	Zestaw wálki i piłki do masażu / Roller ball massage set / Sada masážního válece a míče	Walek fitness/ roller / Roller / Váleček/roller	Walek fitness/ roller / Roller / Váleček/roller	Walek fitness/ roller / Roller / Váleček/roller	Walek fitness/ roller / Roller / Váleček/roller	Dwuczęściowy skręcany walek fitness/roller / Two part twisted roller / Dvoudílný zkrúcený váleček/roller	Walek fitness/ roller / Roller / Váleček/roller	Walek fitness/ roller / Roller / Váleček/roller	Walek fitness/ roller / Roller / Váleček/roller	Walek fitness/ roller / Roller / Váleček/roller	Walek fitness/ roller 2 w 1 / Roller 2 in 1 / Váleček/roller 2 v 1	Walek fitness/ roller 3 w 1 / Roller 3 in 1 / Váleček/roller 3 v 1
Akumulator / Battery / Batterie	•	-	-	-	-	-	-	-	-	-	-	-	
Materiał / Material / Materiál	EPP	EPP	EVA / EVA	EVA / EVA	EPP	EPP	EVA / PP	EVA / PVC	EVA / PVC	EVA / PCV	EVA / PVC	PE / PVC / ABS	
Wymiary / Dimensions / Rozměry	x	x	x	x	x	x	x	x	x	x	x	x	
Długość / Length / Délka	29,5 cm	30 cm / 8 cm / 15 cm / 24 cm	79 cm	33 cm	45 cm	29,5 cm	68 cm	61 cm	45 cm	33 cm	30 cm / 33 cm	46 cm	
Średnica / Diameter / Průměr	15 cm	15 cm / 8 cm / 5,3 cm / 12 cm	15 cm	14 cm	15 cm	15 cm	14 cm	14 cm	14 cm	14 cm	14 / 10 cm	10,5 / 14,5	
Twardość (w skali Shore'a) / Hardness (on a Shore scale) / Tvrdost (na stupnici Shore'a)	55	55	55 / 55 - 60	55 - 60	55 / 55 - 60	55	50	50	50	50	50	45	
Maksymalne obciążenie / Maximu load / Maximální hmotnost	250 kg	250-100 kg	350 kg	200 kg	250 kg	250 kg	200 kg	200 kg	200 kg	200 kg	200 kg	120 kg	
Ilość w opakowaniu zbiorczym / Multipacking / Počet w veľkoobchodního balení	10	10	10	10	10 / 20	20	10	10	10	10	10	8	
Wymiary opakowania zbiorczego / Multipack dimensions / Rozměry veľkoobchodního balení	76 x 31 x 35 cm	85 x 33 x 64	78 x 32 x 82 cm	70 x 31 x 37 cm	76 x 31 x 47 cm / 77 x 32 x 92 cm	76 x 31 x 61 cm	73 x 30 x 70 cm	72 x 29 x 63 cm	72 x 30 x 47 cm	72 x 30 x 35 cm	72 x 30 x 35 cm	60 x 31 x 48 cm	
Waga opakowania zbiorczego / Multipack weight / Hmotnost veľkoobchodního balení	8 kg	7,3 kg	21 kg	7 kg	3,5 kg / 6,6 kg	4,5 kg	18 kg	18 kg	14 kg	10 kg	14,5 kg	11 kg	

Model / Model / Třída	FS111	FS101	FS110	FS108	FS201	FS106	FS202	FS116	BLC01	BLC02	BLM01	BLM02
	Walek fitness/ roller / Roller / Váleček/roller	Walek fitness/ roller / Roller / Váleček/roller	Walek fitness/ roller / Roller / Váleček/roller	Walek fitness/ roller / Roller / Váleček/roller	Walek fitness/ roller / Roller / Váleček/roller	Walek fitness/ roller / Roller / Váleček/roller	Walek fitness/ roller / Roller / Váleček/roller	Walek fitness/ roller / Roller / Váleček/roller	Silikonowa piłka masująca / Massage ball / Masážní koule	Silikonowa piłka masująca / Massage ball / Masážní koule	Piłka masująca / Massage ball / Masážní koule	Piłka masująca / Massage ball / Masážní koule
Akumulator / Battery / Batterie	-	-	-	-	-	-	-	-	-	-	-	-
Materiał / Material / Materiál	EVA / ABS	EVA / ABS	EVA	EVA	EVA	EPE	EPP	EPP	Silikon / Silicone / Silikony	Silikon / Silicone / Silikony	EPP	EPP
Wymiary / Dimensions / Rozměry	-	-	-	-	-	-	-	-	6,5 cm	12,5 cm x 6,5 cm	6/8/10 cm	8 x 16 / 12 x 24 cm
Długość / Length / Délka	33 cm	33 cm	33 cm	33 cm	45 cm	45 cm	30 cm	15 cm	-	-	-	-
Średnica / Diameter / Průměr	14 cm	14 cm	14 cm	14 cm	15 cm	15 cm	15 cm	5,3 m	-	-	-	-
Twardość (w skali Shore'a) / Hardness (on a Shore scale) / Tvrdost (na stupnici Shore'a)	55	50	35	50	25	45	55	55	50	50	70	70
Maksymalne obciążenie / Maximu load / Maximální hmotnost	250 kg	300 kg	250 kg	250 kg	120 kg	120 kg	250 kg	100 kg	320 kg	320 kg	150 kg	150 kg
Ilość w opakowaniu zbiorczym / Multipacking / Počet w veľkoobchodního balení	10	10	10	10	10	20	20	200	60	40	100	100/50
Wymiary opakowania zbiorczego / Multipack dimensions / Rozměry veľkoobchodního balení	72 x 30 x 35 cm	74 x 31 x 35 cm	72 x 30 x 35 cm	74 x 31 x 35 cm	76 x 31 x 47 cm	77 x 32 x 93 cm	77 x 32 x 62 cm	55 x 28 x 62 cm	41,5 x 20 x 27cm	54 x 24 x 25cm	33 x 33 x 27cm/ 43 x 43 x 35cm / 52 x 42 x 52cm	82 x 34 x 42 cm/ 62 x 50 x 60cm
Waga opakowania zbiorczego / Multipack weight / Hmotnost veľkoobchodního balení	8 kg	7,5	7 kg	7,5	3,5 kg	9 kg	4,5 kg	5 kg	9,8kg	14,2kg	1,9kg/ 3,3kg/ 5,3kg	5,3kg/ 8kg



WA14



Exercise wheel and mat

17-38-020



WA10



Exercise wheel

17-38-016



WA06



Exercise wheel

17-38-012



WA04



Exercise wheel

17-38-010



WA03



Exercise wheel

17-38-008



Model / Model / Třída	WA14	WA10	WA06	WA04	WA03
Walek szeroki / Exercise wheels / Široký váleček	Walek szeroki / Exercise wheels / Široký váleček	Walek szeroki / Exercise wheels / Široký váleček	Duży walek / Exercise wheels / Velký váleček	Walek szeroki / Exercise wheels / Široký váleček	Walek podwójny / Exercise wheels / Jednoduchý váleček
Antypoślizgowe wykończenie kółka / Non slip wheel tread / Protiskluzové konce kolečka	•	•	•	•	•
Antypoślizgowe rączki / Non slip handles / Protiskluzové rukojeti	•	•	•	•	•
Rączki pokryte gumą / Handles covered with rubber / Rukojeti s guma	-	•	-	-	•
Rączki pokryte pianką / Handles covered with foam / Rukojeti s pénuou	-	-	•	•	-
Uchwyt na ręce i stopy / Support for hands and feet / Držák ruce a nohy	-	-	•	-	-
Podwójne koła prowadzące / Double guide wheels / Dvě vodící kolečka	-	-	-	-	•
Dołączone akcesoria / Attached accessories / Příslušenství	Mata 1 szt. / Mat 1 pcs. / Podložka 1 ks. Wymiary / Dimensions / Rozměry: 20 x 30 x 2 cm	Podkładki na kolana 2 szt. / Knee pads 2 pcs. / Podložky pod kolena 2 ks. Wymiary /Dimensions / Rozměry: 15,5 x 19,5 cm	-	-	-
Materiał / Material / Materiál	PP, TPR	PU, PP, Stal / PU, PP, Steel / PU, PP, Ocel	Guma, PP, Stal / Rubber, PP, Steel / Guma, PP, Ocel	TPR, PP, Stal / TPR, PP, Steel / TPR, PP, Ocel	Plastik, Guma / Plastic, Rubber / Plast, Guma
Średnica kółka / Wheel diameter / Průměr kolečka	19,9 cm	19 cm	33,5 cm	17,5 cm	19 cm
Długość uchwytów / Length of grip / Délka úchytu	15,6 cm	14 cm	13 cm	11,5 cm	27 cm
Szerokość kółka / Wheel width / Šířka kolečka	9 cm	16,5 cm	4,5 cm	5 cm	2 cm
Waga netto/brutto / Weight netto / brutto / Hmotnost produktunetto / brutto	0,5 / 0,6 kg	1,9 / 2,025 kg	3 / 3,2 kg	0,65 / 0,7 kg	0,563 / 0,7 kg
Wymiary opakowania / Packaging dimensions / Rozměry balení	30,4 x 11 x 20 cm	21 x 21 x 22 cm	43 x 43 x 10 cm	29 x 22 x 5,5 cm	27 x 22 x 5 cm
Ilość w opakowaniu zbiorczym / Multipacking / Počet w veľkoobchodního balení	1	8	5	20	20
Wymiary opakowania zbiorczego / Multipack dimensions / Rozměry veľkoobchodního balení	30,4 x 11 x 20 cm	43 x 42 x 84 cm	45 x 45 x 53 cm	46 x 31 x 57 cm	56 x 46 x 30 cm
Waga opakowania zbiorczego / Multipack weight / Hmotnost veľkoobchodního balení	-	29 kg	16 kg	15 kg	13,5 kg







MIX SET GU04 PRO



Exercise band

17-33-101



MIX SET GU05



Rubbers set for exercises

17-33-102



MIX SET GU04



Rubber set for exercises

17-33-120



MIX SET GU05/GU04/TP01



Rubbers set for exercises

17-33-100





GU05



Exercise band

- 17-33-027 ORANGE 101 x 4.5 x 2080 MM
- 17-33-026 LIME 83 x 4.5 x 2080 MM
- 17-33-025 BLUE 64 x 4.5 x 2080 MM
- 17-33-024 GREEN 45 x 4.5 x 2080 MM
- 17-33-023 PURPLE 32 x 4.5 x 2080 MM
- 17-33-022 BLACK 22 x 4.5 x 2080 MM
- 17-33-021 RED 13 x 4.5 x 2080 MM
- 17-33-020 YELLOW 6,4 x 4.5 x 2080 MM



GU06



Exercise band

- 17-33-034 ORANGE/BLACK 29 x 5 x 2250 MM
- 17-33-032 BLUE/BLACK 21 x 5 x 2250 MM
- 17-33-031 GREEN/BLACK 17 x 5 x 2250 MM
- 17-33-030 PINK/BLACK 13 x 5 x 2250 MM



RB01



Exercise band in roll

- 17-34-011 BLUE 0,8 x 150 MM / 50 M
- 17-34-010 PURPLE 0,4 x 150 MM / 50 M





FB01



Exercise band

17-34-015



TP01



Exercise band

- 17-34-020 BLACK 1,2 x 150 x 1800 MM
- 17-34-021 GRAY 0,75 x 150 x 1500 MM
- 17-34-022 PINK 0,7 x 120 x 1200 MM



GU02



Exercise band

17-33-005



GU04



Exercise band

- 17-33-013 BLACK 1,2 x 50 x 600 MM
- 17-33-012 BLUE 0,9 x 50 x 600 MM
- 17-33-011 RED 0,7 x 50 x 600 MM
- 17-33-010 YELLOW 0.4 x 50 x 500 MM





Model / Model / Třída	MIX SET GU04 PRO	MIX SET GU05	MIX SET GU04	MIX SET GU05/GU04/TP01	GU05	GU06
	Guma do ćwiczeń / Exercise band / Gumový expandér	Zestaw gum treningowych / Rubbers set for exercises / Sestava gum na cviky	Zestaw gum treningowych / Rubbers set for exercises / Sestava gum na cviky	Zestaw gum treningowych / Rubbers set for exercises / Sestava gum na cviky	Guma do ćwiczeń / Exercise band / Gumový expandér	Guma do ćwiczeń / Exercise band / Gumový expandér
Material / Material / Materiál	Lateks / Latex / Latex	Lateks / Latex / Latex	Lateks / Latex / Latex	Lateks / Latex / Latex	Lateks / Latex / Latex	Lateks / Latex / Latex
Wymiary / Dimensions / Rozměry	600 x 50 x 2 mm / 600 x 50 x 1,6 mm / 600 x 50 x 1,2 mm	2080 x 4,5 x 32 mm / 2080 x 4,5 x 13 mm / 2080 x 4,5 x 6,4 mm	600 x 50 x 1,2 mm / 600 x 50 x 0,9 mm / 600 x 50 x 0,7 mm / 600 x 50 x 0,4 mm	GU05: 2080 x 4,5 x 32 mm / 2080 x 4,5 x 13 mm GU04: 600 x 50 x 0,9 mm / 500 x 50 x 0,4 mm TP01: 1800 x 150 x 1,2 mm / 1500 x 150 x 0,75 mm	2080 x 4,5 x 101 mm / 2080 x 4,5 x 83 mm / 2080 x 4,5 x 64 mm / 2080 x 4,5 x 45 mm / 2080 x 4,5 x 32 mm / 2080 x 4,5 x 22 mm / 2080 x 4,5 x 13 mm / 2080 x 4,5 x 6,4 mm	29 x 5 x 2250 mm / 21 x 5 x 2250 mm / 17 x 5 x 2250 mm / 13 x 5 x 2250 mm
Zakres obciążenia / Load range / Rozsah zatížení	13,5 - 27 kg / 9 - 22,5 kg / 4,5 - 15,75 kg	15,88 - 38,56 kg / 6,8 - 15,88 kg / 1,81 - 5,44 kg	18 - 25 kg / 13,5 - 20,5 kg / 9 - 16 kg / 4,5 - 7 kg	GU05: 15,9 - 38,6 kg / 6,8 - 15,9 kg GU04: 13,5 - 20,5 kg / 4,5 - 7 kg TP01: 25 - 16 kg	45,63 - 158,76 kg / 38,56 - 104,33 kg / 29,48 - 79,38 kg / 22,68 - 56,7 kg / 15,88 - 38,56 kg / 11,34 - 29,48 kg / 6,8 - 15,88 kg / 1,81 - 5,44 kg	18 - 40,5 kg / 13,5 - 27 kg / 9 - 22,5 kg / 6,75 - 18 kg
Ilość w opakowaniu zbiorczym / Multipacking / Počet w veľkoobchodního balení	100	20	150	20	20 / 20 / 50 / 50 / 50 / 50 / 50 / 50	40

Model / Model / Třída	RB01	FB01	TP01	GU02	GU04
	Guma do ćwiczeń w rolce / Exercise band in roll / Gumový expandér v roli	Guma do ćwiczeń / Exercise band / Gumový expandér	Guma do ćwiczeń / Exercise band / Gumový expandér	Guma treningowa / Exercise band / Cvičební gummy	Guma do ćwiczeń / Exercise band / Gumový expandér
Material / Material / Materiál	Lateks / Latex / Latex	Lateks / Latex / Latex	Lateks / Latex / Latex	Lateks / Latex / Latex	Lateks / Latex / Latex
Wymiary / Dimensions / Rozměry	50 x 150 x 0,4 mm / 50 x 150 x 0,8 mm	2080 x 50 x 1,2 mm	1800 x 150 x 1,2 mm / 1500 x 150 x 0,75 mm / 1200 x 120 x 0,7 mm	1200 x 120 x 0,5 mm	600 x 50 1,2 mm / 600 x 50 x 0,9 mm / 600 x 50 x 0,7 mm/ 500 x 50 x 0,4 mm
Zakres obciążenia / Load range / Rozsah zatížení	9 / 16 kg	9 kg	25 / 16 / 13,5 kg	13 / 15 kg	18 - 25 kg / 13,5 - 20,5 kg / 9 - 16 kg / 4,5 - 7 kg
Ilość w opakowaniu zbiorczym / Multipacking / Počet w veľkoobchodního balení	3	100	50 / 100 / 150	200	200 / 250 / 500



TX02



Exercise set
17-35-003



TX01



Exercise set
17-35-002



TX30



Exercise set
17-35-035





EG06



Expander with counter
17-31-006



EP01



Pilates expander
17-32-001



EP02



Pilates expander
17-32-002



EG02



Expander
17-31-002





EG03



Expander
17-31-003



EM01



Expander
17-30-001



EM09



Expander
17-30-009

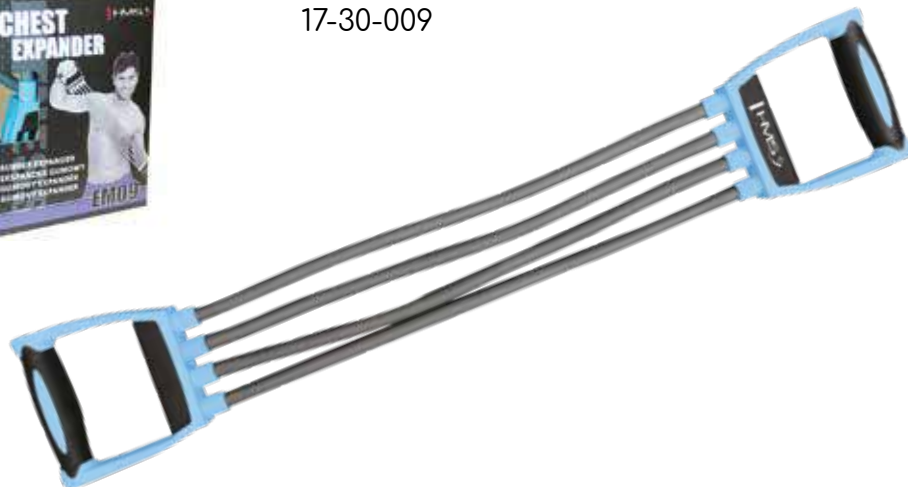

EM08



Expander
17-30-008

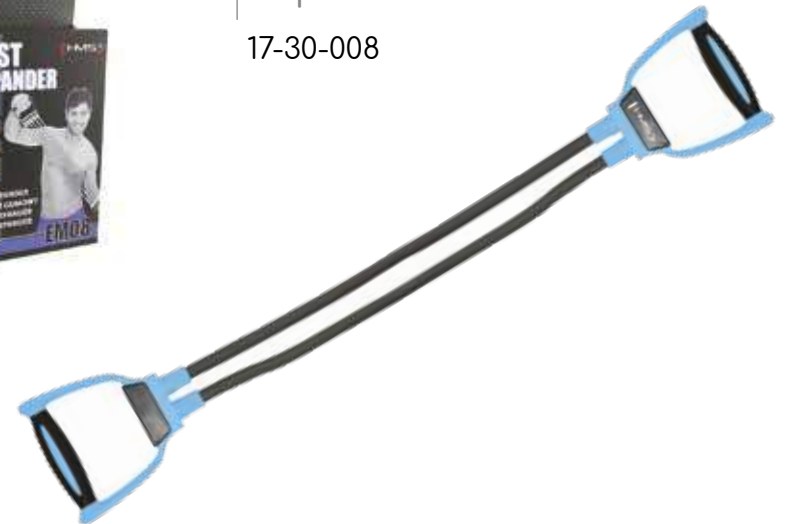



Model / Model / Třída	TX02	TX01	TX30
	Zestaw do ćwiczeń siłowych / Exercise set / Sestava gum na posilování	Zestaw do ćwiczeń siłowych / Exercise set / Sestava gum na posilování	Zestaw do ćwiczeń siłowych / Exercise set / Sestava gum na posilování
W zestawie / Included / V sadě	Gumy oporowe: 4 szt., guma elastyczna, opaska oporowa, uchwyt piankowy na rękę: 2 szt., uchwyt na kostkę, uchwyt pod drzwi, skakanka / Rubber resistance band: 4 pcs., fitness stretch band, shape expander, foam covered handle: 2 pcs., ankle strap, door anchor, jump rope / Gumy o różnych twardości: 4 ks., elastyczny pasek, odporový pasek, pěnové rukojeti: 2 ks., úchyt na kotník, úchyt ke dveřím, švihadlo	Gumy oporowe: 3 szt., uchwyt piankowy na rękę: 2 szt., uchwyt na kostkę, uchwyt pod drzwi / Rubber resistance band: 3 pcs., foam covered handle: 2 pcs., ankle strap, door anchor / Gumy o różnych twardości: 3 ks., pěnové rukojeti: 2 ks., úchyt na kotník, úchyt ke dveřím	Gumy oporowe: 5 szt., uchwyt piankowy na rękę: 2 szt., uchwyt na kostkę: 2 szt., uchwyt pod drzwi / Rubber resistance band: 5 pcs., foam covered handle: 2 pcs., ankle strap: 2 pcs., door anchor / Gumy o różnych twardości: 5 ks., pěnové rukojeti: 2 ks., úchyt na kotník: 2 pcs., úchyt ke dveřím
Kolory / Colours / Barvy	-	-	Czerwony, niebieski, czarny, żółty, zielony / Red, blue, black, yellow, green / Červená, Modrý, Černý, Žlutý, Zelená
Długości gum oporowych / Resistance band length / Délka guma odpor	-	-	1200 mm
Wymiary gum oporowych / Resistance band dimensions / Rozměry guma odpor	1400 x 10 x 6 mm / 600 x 10 x 6 mm / 1200 x 12 x 7 mm / 600 x 12 x 7 mm	1200 x 12 x 8 mm / 1200 x 10 x 7 mm / 1200 x 9 x 6 mm	-
Wymiary gumy elastycznej / Fitness stretch band dimensions / Rozměry elastický pásek	1200 x 120 x 0,4 mm	-	-
Zakres obciążenia / Load range / Rozsah zatížení	13 kg / 13 kg / 15 kg / 15 kg	15 kg / 13 kg / 10 kg	3 kg / 4 kg / 5 kg / 7 kg / 8 kg
Wymiary opaski oporowej / Shape expander dimensions / Rozměry odporový pásek	600 x 10 x 7 mm	-	-
Waga netto/brutto / Weight netto/brutto / Hmotnost produktu netto/brutto	0,7 / 0,72 kg	0,45 / 0,47 kg	0,6 / 0,7 kg
Wymiary opakowania / Packing dimensions / Rozměry balení	30 x 20 x 6 cm	28 x 20 x 4 cm	39 x 26 x 9 cm
Ilość w opakowaniu zbiorczym / Multipacking / Počet w veľkoobchodního balení	42	24	10
Wymiary opakowania zbiorczego / Multipack dimensions / Rozměry veľkoobchodního balení	64 x 47 x 43 cm	43 x 42 x 31 cm	82 x 27 x 23 cm
Waga opakowania zbiorczego / Multipack weight / Hmotnost veľkoobchodního balení	18,5 kg	12 kg	8,5 kg



Model / Model / Třída	EG06	EP01	EP02	EG02	EG03	EM01	EM09	EM08
	Ekspander z licznikiem / Expander with counter / Expandér s počítadlem	Ekspander pilates z uchwytyami / Pilates expander / Expandér pilates s úchopy	Ekspander pilates z uchwytyami / Pilates expander / Expandér pilates s úchopy	Expander / Expander / Expandér	Expander / Expander / Expandér	Expander / Expander / Expandér	Expander / Expander / Expandér	Expander / Expander / Expandér
Gumowy naciąg / Rubber string / Gumová táhla	•	•	•	•	•	•	•	•
Piankowe uchwyty / Foam handles / Pěnové rukojeti	•	-	-	•	•	-	-	-
Uchwyty z tworzywa sztucznego / Plastic handles / Plastové rukojeti	-	•	•	-	-	•	•	•
Licznik LCD / Counter LCD / LCD displej	Zegar, czas, licznik rozciągnięć, kcal, całkowita liczba rozciągnięć / Clock, timer, accurate pull cont, calories, total pull cont / Hodiny, čas tréninku, počítačlo roztažení kalorii, celkový počet roztažení	-	-	-	-	-	-	-
Wymiary / Dimensions / Rozměry	-	550 x 150 x 0,5 mm	650 x 150 x 0,65 mm	-	-	-	-	-
Średnica rączki / Grip diameter / Průměr úchopu	25 mm	-	-	2,5 mm	2,5 mm	-	-	-
Średnica gumy / Rubber diameter / Průměr gumy	7 mm	-	-	7 mm	7 mm	-	-	-
Długość całkowita / Total length / Celková délka	44 cm	74 cm	85,5 cm	142 cm	46 cm	78 cm	74 cm	74 cm
Długość naciągu / Rubber string length / Délka táhel	44 cm	56 cm	67 cm	125 cm	46 cm	54 cm	50 cm	50 cm
Waga netto/brutto / Weight netto / brutto / Hmotnost produktu netto / brutto	0,1 / 0,15 kg	0,24 / 0,28 kg	0,26 / 0,30 kg	0,14 / 0,21 kg	0,9 / 0,15 kg	0,3 / 0,42 kg	0,39 / 0,49 kg	0,33 / 0,4 kg
Wymiary opakowania / Packaging dimensions / Rozměry balení	22 x 14 x 3,5 cm	18 x 14 x 4 cm	18 x 14 x 4 cm	15 x 13 x 7 cm	16 x 15 x 4,5 cm	16 x 14 x 4 cm	22 x 17 x 6,5 cm	22 x 16,5 x 6,5 cm
Ilość w opakowaniu zbiorczym / Multipacking / Počet w veľkoobchodního balení	40	40	40	60	60	12	12	48
Wymiary opakowania zbiorczego / Multipack dimensions / Rozměry veľkoobchodního balení	36 x 29 x 41 cm	44,5 x 38 x 30 cm	44,5 x 38 x 30 cm	52,5 x 28,5 x 47 cm	52,5 x 25,5 x 47 cm	48,5 x 30 x 26 cm	46 x 35 x 22 cm	51 x 46 x 57 cm
Waga opakowania zbiorczego / Multipack weight / Hmotnost veľkoobchodního balení	7 kg	11,1 kg	12,3 kg	9 kg	6,3 kg	6,3 kg	10,5 kg	16 kg



KO03



Figure trimmer

17-38-102





KO02



Figure trimmer

17-38-101



KO01



Figure trimmer

17-38-100



Model / Model / Třída	KO03	KO02	KO01
Krażek obrotowy / Figure trimmer / Rotana		Krażek obrotowy / Figure trimmer / Rotana	Krażek obrotowy / Figure trimmer / Rotana
Espandery do ćwiczeń / Exercise expanders / Cvičebni expandéry	•	•	-
Antypoślizgowa powierzchnia / non-slip foot pad / antiskluzový povrch	•	•	•
Licznik z wyświetlaczem LCD / LCD counter / LCD počítadlo	•	-	-
Wbudowane magnesy pobudzające krążenie krwi / magnets stimulate blood circulation / Magnety stimulují krevní oběh	•	-	•
Materiał / Material / Materiál	ABS	PP	PP
Średnica / Disc diameter / Průměr disku	25 cm	25 cm	25 cm
Wysokość / Height / Výška	2,5 cm	2,5 cm	2,5 cm
Długość linki ekspndera/ Cable length / Délka lanka	60 cm	60 cm	-
Waga netto / brutto / Weight netto / brutto / Hmotnost produktu netto / brutto	0,735 / 0,899 kg	0,7 / 0,75 kg	0,6 / 0,65 kg
Maksymalna waga użytkownika / Maximum user weight / Maximální uživatelská hmotnost	100 kg	100 kg	100 kg
Wymiary opakowania / Packaging dimensions / Rozměry balení	30 x 30 x 6 cm	32 x 26 x 4 cm	26 x 26 x 4 cm
Ilość w opakowaniu zbiorczym / Multipacking / Rozměry balení	20	20	20
Wymiary opakowania zbiorczego / Multipack dimensions / Rozměry velkoobchodního balení	63 x 31,5 x 62 cm	54,5 x 35 x 43,5 cm	53,5 x 27,5 x 38,5 cm
Waga opakowania zbiorczego / Multipack weight / Hmotnost velkoobchodního balení	16 kg	16,9 kg	14,5 kg



SK55



Speed jump rope

- 17-36-212 GREEN
- 17-36-211 BLUE



SK52



Speed jump rope

- 17-36-204 SILVER
- 17-36-205 RED/BLACK



SK54



Speed jump rope

- 17-36-209 BLACK/RED
- 17-36-208 BLACK/SILVER



SK50



Speed jump rope

- 17-36-200





SK46

Jump rope
17-36-046



SK23

Jump rope
17-36-023



SK31

Jump rope
17-36-031



SK08

Jump rope
17-36-008





SK12

Jump rope
17-36-012



SK98

Jump rope
17-36-098



SK38

Jump rope
17-36-038



SK17

Jump rope
17-36-017





SK03

Jump rope
17-36-003



SK07

Jump rope
17-36-007



SK43

Jump rope
17-36-043



SK01

Jump rope
17-36-001





SC13



Hand grips with hard handles

17-37-013



SC20



Hand grips with hard handles

17-37-020



Model / Model / Třída	SK55	SK54	SK52	SK50	SK46
	Skakanka szybka / Jump rope / Švihadlo	Skakanka szybka / Jump rope / Švihadlo	Skakanka szybka / Jump rope / Švihadlo	Skakanka / Jump rope / Švihadlo	Skakanka / Jump rope / Švihadlo
Kolor / Colour / Barva	Niebieski / Zielony / Blue / Green / Modry / Zelená	Czerwony / Srebrny / Red / Silver / Červená / Stříbro	Czerwony / Srebrny / Red / Silver / Červená / Stříbro	Czarny / Black / Černá	Czerwony / Red / Červená
Łożyska w uchwytach / Bearings in the handles / Ložiska v ručkách	•	•	•	-	-
Możliwość regulacji długości linki / Adjustable length / Možnost nastavení délky lanka	•	•	•	•	-
Licznik LCD / LCD counter / LCD počítadlo	-	-	-	-	•
Licznik / Counter / Počítadlo	-	-	-	-	-
Dodatkowe obciążenie / Extra weight / Přídavné závaží	-	-	-	-	-
Linka / String / Lanko	Stal pokryta PU / Steel covered PU / Ocel pokrytá PU	Stal pokryta PU / Steel covered PU / Ocel pokrytá PU	Stal pokryta PU / Steel covered PU / Ocel pokrytá PU	Stal / Steel / Ocel	Guma / Rubber / Guma
Uchwyty / Handles / Ručky	PVC	Aluminium + PVC / Aluminium + PVC / Hliník + PVC	Aluminium / Aluminium / Hliník	PP	ABS
Opór / Resistance / Zátěže	-	-	-	-	-
Sprężyna / Spring / Pruzina	-	-	-	-	-
Długość linki / String length / Délka lanka	300 cm	300 cm	300 cm	280 cm	275 cm
Długość rączki / Handles length / Délka ručky	17 cm	15 cm	15 cm	13 cm	16,5 cm
Waga netto / brutto / Weight netto / brutto / Hmotnost produktu netto / brutto	0,14 / 0,17 kg	0,2 / 0,23 kg	0,184 / 0,235 kg	0,1 / 0,15 kg	0,2 / 0,25 kg
Wymiary opakowania / Packaging dimensions / Rozměry balení	19 x 12 x 4 cm	19 x 12 x 4 cm	23,5 x 12 x 3 cm	18 x 12 x 4 cm	23 x 13 x 4 cm
Ilość w opakowaniu zbiorczym / Multipacking / Počet w veľkoobchodní balení	48	48	40	40	40
Wymiary opakowania zbiorczego / Multipack dimensions / Rozměry veľkoobchodního balení	58 x 49 x 17,5 cm	58 x 49 x 17,5 cm	53 x 33 x 28 cm	32 x 25 x 43 cm	43 x 27 x 47 cm
Waga opakowania zbiorczego / Multipack weight / Hmotnost veľkoobchodního balení	8 kg	11 kg	12,5 kg	7 kg	9 kg



SK31	SK23	SK08	SK12	SK38	SK98	SK17	SK03	SK43	SK07	SK01	SC13	SC20
Skakanka / Jump rope / Śvihadlo	Skakanka / Jump rope / Śvihadlo	Skakanka / Jump rope / Śvihadlo	Skakanka / Jump rope / Śvihadlo	Skakanka / Jump rope / Śvihadlo	Skakanka / Jump rope / Śvihadlo	Skakanka / Jump rope / Śvihadlo	Skakanka / Jump rope / Śvihadlo	Skakanka / Jump rope / Śvihadlo	Skakanka / Jump rope / Śvihadlo	Skakanka / Jump rope / Śvihadlo	Ściskacz twarde / Hand grips with hard handles / Posilovač zápěstí	Ściskacz twarde / Hand grips with hard handles / Posilovač zápěstí
Zielony / Green / Zelená	Niebieski / Blue / Modry	Niebieski / Blue / Modry	Pomarańczowy / Orange / Oranżový	Niebieski / Blue / Modry	Czerwony / Red / Červená	Niebieski / Blue / Modry	Czarny / Black / Černá	Czarny / Black / Černá	Drewno / Wood / Dříví	Drewno / Wood / Dříví	-	-
•	-	-	-	-	-	•	•	•	•	-	-	-
-	-	-	-	-	-	-	-	-	-	-	-	-
•	•	-	-	-	-	-	-	-	-	-	-	-
-	-	•	•	-	-	-	-	-	-	-	-	-
-	-	-	-	-	-	2 x 125 g	-	-	-	-	-	-
PCV	Guma / Rubber / Guma	Sznurek / Cotton rope / Bavlněná šňůra	Guma / Rubber / Guma	Guma / Rubber / Guma	Guma / Rubber / Guma	Skóra / Leather / Kožené	Skóra / Leather / Kožené	Skóra / Leather / Kožené	Skóra / Leather / Kožené	Sznurek / Cotton rope / Bavlněná šňůra	-	-
PP	PP	ABS, TPR	ABS, TPR	ABS, TPR	Plastik / Plastics / Plasty	PVC, pianka / PVC, foam / PVC, pěna	Plastik, pianka / Plastics, foam / Plasty, pěna	Drewno / Wood / Dříví	Drewno / Wood / Dříví	Drewno / Wood / Dříví	Aluminium / Aluminium / Hliník	ABS, TPR
-	-	-	-	-	-	-	-	-	-	-	45 kg	10 - 40 kg
-	-	-	-	-	-	-	-	-	-	-	Stal / Steel / Ocel	Stal / Steel / Ocel
275 cm	270 cm	270 cm	275 cm	275 cm	275 cm	270 cm	275 cm	270 cm	270 cm	280 cm	-	-
16,5 cm	17 cm	16 cm	19 cm	15 cm	13 cm	14 cm	13 cm	14 cm	14 cm	11,5 cm	-	-
0,138 / 0,195 kg	0,2 / 0,25 kg	0,139 / 0,198 kg	0,3 / 0,35 kg	0,25 / 0,3 kg	0,15 / 0,2 kg	0,5 / 0,55 kg	0,145 / 0,186 kg	0,4 / 0,45 kg	0,24 / 0,29 kg	0,15 / 0,2 kg	0,19 / 0,2 kg	0,5 / 0,40 kg
24 x 13 x 4 cm	23,5 x 12,5 x 4 cm	23,5 x 12,5 x 4,5 cm	24 x 13 x 4 cm	21 x 11,5 x 5 cm	21 x 12 x 5 cm	18 x 12 x 3 cm	18,5 x 12,5 x 3,5 cm	23 x 13 x 4 cm	24 x 13 x 4 cm	18 x 12 x 4 cm	13,5 x 11 x 3 cm	20 x 12 x 2,5 cm
40	40	40	40	40	40	40	40	40	40	48	50	40
42 x 27 x 47 cm	44 x 27 x 47 cm	42 x 27 x 48 cm	43 x 27 x 47 cm	35 x 25 x 50 cm	40 x 34 x 25 cm	32 x 25 x 43 cm	32 x 25 x 44 cm	43 x 27 x 44 cm	42 x 27 x 47 cm	41,5 x 38 x 28 cm	48 x 30 x 26 cm	33 x 26 x 34 cm
8 kg	11 kg	8 kg	14 kg	11 kg	7 kg	19 kg	8 kg	14 kg	11,5 kg	8 kg	11 kg	12 kg





WLB 15/12/10/8/6/4



Excercise ball - Wall Ball



- 17-41-030 15 KG
- 17-41-029 12 KG
- 17-41-028 10 KG
- 17-41-027 8 KG
- 17-41-026 6 KG
- 17-41-025 4 KG

PSB 22/18/15/13/9/5/3



Excercise ball - Slam Ball



- 17-41-018 22 KG
- 17-41-017 18 KG
- 17-41-016 15 KG
- 17-41-015 13 KG
- 17-41-013 10 KG
- 17-41-012 9 KG
- 17-41-011 8 KG
- 17-41-008 5 KG
- 17-41-006 3 KG



WBF 25/20/15/10/05



Training bag



- 17-63-005 25 KG
- 17-63-004 20 KG
- 17-63-003 15 KG
- 17-63-002 10 KG
- 17-63-001 5 KG



WDC 25/20/15/10/05



Power bag



- 17-63-014 25 KG
- 17-63-013 20 KG
- 17-63-012 15 KG
- 17-63-011 10 KG
- 17-63-010 5 KG





PW20



Push up bars
17-45-010



PW10



Push up bars
17-45-009



PU08



Push up bars
17-45-008



PU05



Push up bars
17-45-005





Model / Model / Třída	WLB 15/12/10/8/6/4	PSB 22/18/15/13/9/5/3	WBF 25/20/15/10/05	WDC 25/20/15/10/05
	Piłka do ćwiczeń - Wall Ball / Exercise ball - Wall Ball / Cvičení míč - Wall Ball	Piłka do ćwiczeń - Slam Ball / Exercise ball - Slam Ball / Cvičení míč - Slam Ball	Worek treningowy / Training bag / Tréninkový vak	Power bag / Power bag / Napájeci taška
Material / Material / Materiál	Skóra syntetyczna / Synthetic leathe / Syntetická kůže	Skóra syntetyczna / Synthetic leathe / Syntetická kůže	PU, poliester, guma / PU, polyester, rubber / PU, polyester, pryž	PU, poliester, guma / PU, polyester, rubber / PU, polyester, pryž
Waga / Weight / Hmotnost	4 / 6 / 8 / 10 / 12 / 15 kg	3 / 5 / 9 / 13 / 15 / 18 / 22 kg	5 / 10 / 15 / 20 / 25	5 / 10 / 15 / 20 / 25
Wymiary / Dimensions / Rozměry	∅ 33 cm	∅ 22,5 / ∅ 22,5 / ∅ 23 / ∅ 24,5 / ∅ 27 / ∅ 27 / ∅ 28 cm	73 x 19 x 48 cm	56 x 22 cm
Wymiary opakowania / Packaging dimensions / Rozměry balení	34 x 34 x 34 cm	24,5 x 24 x 24/ 24,5 x 24 x 24/ 24 x 24,5 x 25,5/ 26,5 x 27 x 28/ 29 x 28,5 x 28/ 26 x 26,5 x 28/ 26,5 x 26,5 x 28 cm	75 x 21 x 50 cm	58 x 24 x 24 cm
Waga opakowania / Packaging weight / Hmotnost balení	4,5 / 6,5 / 8,5 / 10,5 / 12,5 / 15,5 kg	3,3 / 5,3 / 9,3 / 13,3 / 15,5 / 18,3 / 22,3 kg	5,5 / 10,5 / 15,5 / 20,5 / 25,5 kg	5,5 / 10,5 / 15,5 / 20,5 / 25,5 kg

Model / Model / Třída	PW20	PW10	PU08	PU05
	Podpórki do pompek /Push up bars / Podpěry pro kliky	Podpórki do pompek/ Push up bars / Podpěry pro kliky	Podpórki do pompek / Push up bars / Podpěry pro kliky	Podpórki do pompek / Push up bars / Podpěry pro kliky
Material / Material / Materiál	Żelazo, pianka / Iron, foam / Železo, pěnovka	Żelazo / Iron / Železo	ABS	PP
Zestaw zawiera / Set include / Součástí soupravy jsou	2 szt. / 2 pcs. / 2 ks.	2 szt. / 2 pcs. / 2 ks.	2 szt. / 2 pcs. / 2 ks.	2 szt. / 2 pcs. / 2 ks.
Antypoślizgowe uchwyty / Non-slip handles / Antiskluzová držadla	•	•	•	•
Wymiary / Dimensions/ Rozměry	75,5 x 62 x 36 cm	30 x 60 x 36 cm	12 x 20 x 22 cm	11,5 x 11 x 21 cm
Maksymalna waga użytkownika / Maximum user weight / Maximální uživatelská hmotnost	400 kg	210 kg	150 kg	300 kg
Waga netto/brutto / Weight netto/brutto / Hmotnost produktu netto/brutto	8 / 9 kg	5,8 / 6,3 kg	1,5 / 1,675 kg	0,616 / 0,726 kg
Wymiary opakowania / Packing dimensions / Rozměry balení	65 x 65 x 7 cm	61 x 33 x 7,5 cm	22 x 22 x 16 cm	21,5 x 16,7 x 10,5 cm
Ilość w opakowaniu zbiorczym / Multipacking / Počet w veľkoobchod- ního balení	1	1	8	20
Wymiary opakowania zbiorczego / Multipack dimensions / Rozměry veľkoobchod- ního balení	65 x 65 x 7 cm	61 x 33 x 7,5 cm	46 x 46 x 33 cm	55 x 45 x 36 cm
Waga opakowania zbiorczego / Multipack weight / Hmotnost veľkoobchod- ního balení	9 kg	6,3 kg	15 kg	15 kg



DSC01



Wooden chest

17-62-100



RP02



Training rope

17-62-001





DK06



Quick ladder
17-62-101

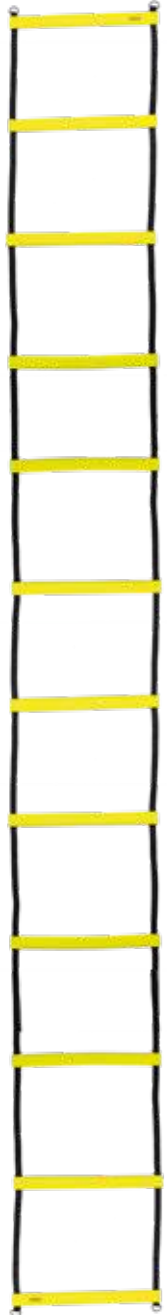

SKR06



Hex rings
17-62-103

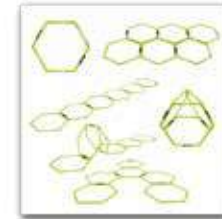

GTR50



Crossfit cone
17-62-102





TX09



Training tape set
17-35-010



TX PRO



Training tape set
17-35-040



TX05



Training rings
17-35-006



TX07



Training rings
17-35-008





F4438



Arm hangers

17-62-028



F4420



Wrist roller

17-62-029



HD02



Neck training device

17-62-034





DD02



Door gym bar
17-45-012



ABX01



Arm blaster
17-62-022



UWZ



Rope holder
17-62-012



URP01



Rope holder
17-62-011



UWX



Rope holder
17-62-010





Model / Model / Třída	DSC01	RP02	DK06	SKR06	GTR50
	Skrzynia drewniana / Wooden chest/ Dřevěné truhly	Lina do ćwiczeń / Training rope / Lano k posilování	Drabinka koordynacyjna / Quick ladder / Počet příček	Siatka koordynacyjna / Hex rings / Počet šestiúhelníků	Grzybki treningowe / Crossfit cone / Počet kuželů
Materiál / Material / Materiál	Drewno / Wood / Dříví	Nylon, poliester, PVC / Nylon, polyester, PVC / Nylon, polyester, PVC	TPE + nylon	PP	PVC
Wymiary / Dimensions/ Rozměry	70 x 50 x 60 cm	15 m x ø 50 mm	6 m x 47 cm	57 x 50 cm	20 x 5 cm
Maksymalna waga użytkownika / Maximum user weight / Maximální uživatelská hmotnost	300 kg	-	-	-	-
Ilość szczebelków / Number of rungs / Počet příček	-	-	12	-	-
Ilość sześciokątów / Number of hex rings / Počet šestiúhelníků	-	-	-	6	-
Ilość grzybków / Number of cones / Počet kuželů	-	-	-	-	50
Waga netto/brutto / Weight netto/brutto / Hmotnost produktu netto/brutto	20 / 21 kg	20 / 21,6 kg	1,65 / 1,8 kg	1,34 / 1,6 kg	1,2 / 1,6 kg
Wymiary opakowania / Packing dimensions / Rozměry balení	78 x 63 x 13 cm	39 x 39 x 32 cm	51 x 10 x 8 cm	57 x 50 cm	33 x 24 x 12 cm
Ilość w opakowaniu zbiorczym / Multipacking / Počet w veľkoobchodného balení	1	1	10	8	20
Wymiary opakowania zbiorczego / Multipack dimensions / Rozměry veľkoobchodného balení	78 x 63 x 13 cm	39 x 39 x 32 cm	52,5 x 21,5 x 42 cm	76 x 53 x 53 cm	46 x 39 x 39,5 cm
Waga opakowania zbiorczego / Multipack weight / Hmotnost veľkoobchodného balení	21 kg	21,6 kg	17 / 18 kg	10,8 / 12,5 kg	23 / 34 kg

Model / Model / Třída	TX09	TX PRO	TX05	TX07	F4438
	Zestaw taśm do ćwiczeń siłowych / Training tape set / Závěsný posilovací systém	Zestaw taśm do ćwiczeń siłowych / Training tape set / Závěsný posilovací systém	Kółka gimnastyczne / Training rings / Gymnastické kruhy	Kółka gimnastyczne / Training rings / Gymnastické kruhy	Rękawy do podciągania / Arm hangers / Rukávy pro přitahy
Materiál / Material / Materiál	Nylon, pianka, stal / Nylon, foam, steel / Nylon, pěnovka, ocel	Nylon, pianka, stal / Nylon, foam, steel / Nylon, pěnovka, ocel	PP, nylon	Drewno, nylon / Wood, nylon / Dříví, nylon	Nylon, pianka / Nylon, foam / Nylon, pěnovka
Zakres regulacji / Adjustment range / Rozsah nastavení	200 - 227 cm	120 - 160 cm	-	-	-
Średnica / grubość kółka / Ring diameter / thickness / Průměr / tloušťka kolečka	-	-	230/28 mm	230/28 mm	-
Długość taśmy / Tape length / Délka pasku	-	-	440 cm	440 cm	-
Długość rękawa / Sleeve length / Délka rukávu	-	-	-	-	50 cm
Szerokość rękawa / Sleeve width / Šířka rukávu	-	-	-	-	20,5 cm
Maksymalne obciążenie / Max load / Maximální zatížení	250 kg	250 kg	200 kg	200 kg	100 kg
Waga netto, brutto / Weight netto, brutto / Hmotnost produktu netto, brutto	1,04/1,167 kg	1,3/1,36 kg	1,5/1,58 kg	1,18/1,31 kg	0,8/0,9 kg
Wymiary opakowania / Packaging dimensions / Rozměry balení	24,3 x 23,3 x 8,9 cm	24 x 23 x 9 cm	24 x 24 x 7 cm	24 x 24 x 7 cm	31,5 x 21,2 x 6 cm
Ilość w opakowaniu zbiorczym / Multipacking / Počet w veľkoobchodného balení	12	8	10	5	10
Wymiary opakowania zbiorczego / Multipack dimensions / Rozměry veľkoobchodného balení	57 x 24,5 x 51 cm	49 x 26 x 37 cm	50 x 26,5 x 37 cm	37,5 x 26,5 x 27 cm	43,5 x 32,5 x 32,5 cm
Waga opakowania zbiorczego / Multipack weight / Hmotnost veľkoobchodného balení	15 kg	11,4 kg	17 kg	9,25 kg	9,5 kg



Model / Model / Třída	F4420	HD02	DD02	ABX01	Model / Model / Třída	UWZ	URP01	UWX
	Przyrząd do ćwiczeń ramię / Wrist roller / Posilovač předloktí	Przyrząd do ćwiczenia mięśni karku / Neck training device / Pomůcka k procvičování svalstva šíje	Dražek rozporowy / Door gym bar / Hrazda	Przyrząd do ćwiczeń bicepsów / Arm blaster / Zařízení pro cvičení biceps		Uchwyt do lin i pasów / Rope holder / Úchop pro lan- ka a popruhy	Uchwyt na linę / Rope holder / Lanová rukojeť	Uchwyt do lin i pasów / Rope holder / Úchop pro lan- ka a popruhy
Materiał / Material / Materiál	Nylon, pianka / Nylon, foam / Nylon, pěknové	Nylon, pianka, stal / Nylon, foam, steel / Nylon, pěnovka, ocel	Chromowana stal nierdzewna, pianka / Chromed stainless, foam / Chromovaná nerezová ocel, pěnovka	Neopren / Neoprene / Neopren	Materiał / Material / Materiál	Stal / Steel / Ocel	Stal / Steel / Ocell	Stal / Steel / Ocel
Wymiary / Dimensions / Rozměry	15 cm x ø 32 mm	-	60-100 cm x ø 40 mm	58,4 x 8,9 cm	Wymiary mocowania / Mounting dimensions / Rozměry uchycení	30 x 5 cm	20 x 5 cm	ø 12 cm
Długość miejsca na obciążenie / Rod length / Délka místa na závaží	16 cm	-	-	-	Wymiary uchwytu / Handle dimensions / Rozměry rukojeti	13,2 x 13,2 cm	12 cm / ø 38 mm	6 x 8,5 cm
Maksymalne obciążenie / Max load / Maximální zatížení	25 kg	100 kg	100 kg	-	Odległość od ściany / Distance from the wall / Vzdálenost od stěny	-	27,7 cm	-
Waga netto, brutto / Weight netto, brutto / Hmotnost produktu netto, brutto	0,8 / 0,88 kg	0,4 / 0,43 kg	1,57 / 1,65 kg	0,85 kg	Mocowanie / Mounting / Uchycení	4 śruby / 4 screws / 4 šrouby	4 śruby / 4 screws / 4 šrouby	4 śruby / 4 screws / 4 šrouby
Wymiary opakowania /Packaging dimensions /Rozměry balení	40 x 11 x 7 cm	15 x 11 x 5 cm	63,5 x 5,5 x 5,5 cm	62 x 9 x 2 cm	Waga netto, brutto / Weight netto, brutto / Hmotnost produktu netto, brutto	1,6/1,8 kg	1,1 / 1,2 kg	0,7/0,75 kg
Ilość w opakowaniu zbiorczym / Multipacking / Počet w veľkoobchod- ného balení	16	30	20	25	Wymiary opakowania / Packaging dimensions / Rozměry balení	19 x 13,5 x 2 cm	30,5 x 24,5 x 6 cm	12,5 x 12,5 x 6 cm
Wymiary opakowania zbiorczego / Multipack dimensions / Rozměry veľkoobchod- ného balení	46 x 40 x 29 cm	51 x 24 x 37 cm	66 x 29 x 24 cm	35 x 28 x 23 kg	Ilość w opakowa- niu zbiorczym / Multipacking / Počet w veľkoobchod- ného balení	10	1	12
Waga opakowania zbiorczego / Multipack weight / Hmotnost veľkoobchod- ného balení	15 kg	13 kg	34 kg	20 kg	Wymiary opakowania zbiorczego / Multipack dimensions / Rozměry veľkoobchod- ného balení	45 x 34 x 35 cm	30,5 x 24,5 x 6 cm	25 x 25 x20 cm
					Waga opakowania zbiorczego / Multipack weight / Hmotnost veľkoobchod- ného balení	11,5 kg	1,2 kg	9 kg







SBP20



Body pump set

17-57-010



SBP25



Body pump set

17-57-015



SBP15



Body pump set

17-57-005



GSG 50/40/30/20/10



Rubber coated barbell

- 17-58-010 50 KG
- 17-58-011 40 KG
- 17-58-012 30 KG
- 17-58-013 20 KG
- 17-58-014 10 KG



GSL 50/40/30/20/10



Curled rubber coated barbell

- 17-58-020 50 KG
- 17-58-021 40 KG
- 17-58-022 30 KG
- 17-58-023 20 KG
- 17-58-024 10 KG



GO700

Olympic bar
17-60-010



GCF700

Crossfit bar
17-60-040



GO450

Olympic bar
17-60-012





GCFD450



Crossfit women's bar

17-60-041



GO320



Olympic bar

17-60-013



GO160



Olympic bar

17-60-024





GOL160



Curl olympic bar

17-60-015



GHX02



Hex bar

17-59-011



GOP 200/180/150/120



Olympic bar

17-60-020 200 CM

17-60-021 180 CM

17-60-022 150 CM

17-60-023 120 CM





Model / Model / Třída	SBP20	SBP25	SBP15
	Sztanga do body pump / Body pump set / Body pump činka	Sztanga do body pump / Body pump set / Body pump činka	Sztanga do body pump / Body pump set / Body pump činka
Zestaw zawiera / Set includes / Součásti soupravy jsou	Sztangę, talerze: niebieskie 2 szt., czerwone 2 szt., zielone 2 szt., zaciski motylkowe 2 szt. / Bar, plates: blues 2 pcs., red 2 pcs., green 2 pcs., collar springs 2 pcs. / Hřidel, kotouče: modrý 2 ks., červená 2 ks., zelená 2 ks., pružinové uzávěry 2 ks.	Sztangę, talerze: 2 x 1,25 kg, 2 x 2,5 kg, 2 x 5 kg, zaciski motylkowe 2 szt. / Bar, plates: 2 x 1,25 kg, 2 x 2,5 kg, 2 x 5 kg, collar springs 2 pcs. / Hřidel, kotouče: 2 x 1,25 kg, 2 x 2,5 kg, 2 x 5 kg, pružinové uzávěry 2 ks.	Sztangę, talerze: 2 x 1,25 kg, 2 x 2,5 kg, 2 x 5 kg, zaciski motylkowe 2 szt. / Bar, plates: 2 x 1,25 kg, 2 x 2,5 kg, 2 x 5 kg, collar springs 2 pcs. / Hřidel, kotouče: 2 x 1,25 kg, 2 x 2,5 kg, 2 x 5 kg, pružinové uzávěry 2 ks.
Material / Material / Materiál	Chromowana stal, guma / Chrome steel, rubber / Chromovaná ogel, guma	Chromowana stal, PP / Chrome steel, PP/Chromovaná ogel, PP	Chromowana stal, guma / Chrome steel, rubber / Chromovaná ogel, guma "
Uchwyt / Hand grip / Rukojet	Pianka antypoślizgowa / Anti-slip foam / Protiskluzová pěna	Pianka antypoślizgowa / Anti-slip foam / Protiskluzová pěna	"Pianka antypoślizgowa / Anti-slip foam / Protiskluzová pěna"
Długość gryfu / Bar length / Délka hřidel	140 cm	131 cm	141 cm
Średnica gryfu / Bar diameter / Průměr hřidel	30 mm	30 mm	25 mm
Talerze / Plates / Kotouče	2 x 1,25 kg / 2 x 2,25 kg / 2 x 5 kg	2 x 1,25 kg / 2 x 2,5 kg / 2 x 5 kg	2 x 1,25 kg / 2 x 2,5 kg / 2 x 5 kg
Waga / Weight / Hmotnost	20 kg (+/- 300g)	20 kg (+/- 300g)	20 kg (+/- 300g)
Waga netto / brutto / Weight netto / brutto / Hmotnost produktu netto / brutto	20 /20,5 kg	20 /20,5 kg	20 /20,5 kg
Wymiary opakowania / Packaging dimensions / Rozměry balení	141 x 25 x 4 cm	134 x 4,5; 22 x 20 x 21 cm	57 x 31 x 16 cm

Model / Model / Třída	GSG	GSL
	Gryf/sztanga stała gumowana / Rubber coated barbell/ Pogumovaná hřidel s kotouči	Gryf/sztanga stała gumowana łamana / Curled rubber coated barbell / Pogumovaná łomená hřidel s kotouči
Material / Material / Materiál	Chromowana stal, guma / Chrome steel, rubber / Chromovaná ogel, guma	Chromowana stal, guma / Chrome steel, rubber / Chromovaná ogel, guma
Uchwyt / Hand grip / Rukojet	Radełkowany / Knurled / Vroubkovaná	Radełkowany / Knurled / Vroubkovaná
Średnica gryfu / Bar diameter / Průměr hřidel	28 mm	28 mm
Talerze / Plates / Kotouče	14 x 5 cm / 16,5 x 6,5 cm / 20 x 8 cm / 20 x 10,5 cm / 20 x 13 cm	14 x 5 cm / 16,5 x 6,5 cm / 20 x 8 cm / 20 x 10,5 cm / 20 x 13 cm
Długość / Length / Délka	100/ 104/ 106/ 110/ 116 cm	100/ 104/ 106/ 110/ 116 cm
Waga / Weight / Hmotnost	10 / 20 / 30 / 40 / 50 kg	10 / 20 / 30 / 40 / 50 kg
Wymiary opakowania / Packaging dimensions / Rozměry balení	100 x 14 cm / 104 x 17 cm / 106 x 20 cm / 110 x 20 cm / 116 x 20 cm	100 x 14 cm / 104 x 17 cm / 106 x 20 cm / 110 x 20 cm / 116 x 20 cm



Model / Model / Třída	GO700	GCF700	GO450	GCFD450	GO320	GO160	GOL160	GOP 200/180/150/120
	Gryf olimpijski / Olympic bar / Olympijská hřídel	Gryf olimpijski męski / Men's olympic bar / Osa olympijská dámská	Gryf olimpijski / Olympic bar / Olympijská hřídel	Gryf olimpijski damski / Women's olympic bar / Osa olympijská męzská	Gryf olimpijski / Olympic bar / Olympijská hřídel	Gryf olimpijski / Olympic bar / Olympijská hřídel	Gryf olimpijski łamany / Curl olympic bar / Olympijská hřídel zlomená	Gryf olimpijski / Olympic bar / Olympijská hřídel
Materiał / Material / Materiál	Chromowana stal hartowana / Hardened chrome steel / Chromovaná kalená ocel	Chromowana stal hartowana / Hardened chrome steel / Chromovaná kalená ocel	Chromowana stal hartowana / Hardened chrome steel / Chromovaná kalená ocel	Chromowana stal hartowana / Hardened chrome steel / Chromovaná kalená ocel	Chromowana stal hartowana / Hardened chrome steel / Chromovaná kalená ocel	Chromowana stal hartowana / Hardened chrome steel / Chromovaná kalená ocel	Chromowana stal hartowana / Hardened chrome steel / Chromovaná kalená ocel	Chromowana stal hartowana / Hardened chrome steel / Chromovaná kalená ocel
Uchwy / Hand grip / Rukojeť	Radełkowany / Knurled / Vroubkovaná	Radełkowany / Knurled / Vroubkovaná	Radełkowany / Knurled / Vroubkovaná	Radełkowany / Knurled / Vroubkovaná	Radełkowany / Knurled / Vroubkovaná	Radełkowany / Knurled / Vroubkovaná	Radełkowany / Knurled / Vroubkovaná	Radełkowany / Knurled / Vroubkovaná
Średnica miejsca na obciążenie / Loading part diameter / Průměr části na závaží	50 mm	50 mm	50 mm	50 mm	50 mm	50 mm	50 mm	50 mm
Średnica uchwytu / Diameter of handgrip / Průměr úchopové části	30 mm	23 mm	30 mm	25 mm	28 mm	30 mm	30 mm	GO120: 25 mm / GO150: 28 mm / GO180: 28 mm / GO200: 28 mm
Zaciski (2 szt.) / Collar (2 pcs.) / Matice (2 ks.)	Szczękowe / Jaw clamps / Čelistové	Szczękowe / Jaw clamps / Čelistové	Szczękowe / Jaw clamps / Čelistové	Szczękowe / Jaw clamps / Čelistové	Szczękowe / Jaw clamps / Čelistové	Szczękowe / Jaw clamps / Čelistové	Szczękowe / Jaw clamps / Čelistové	Gwiazdkowe / Star shaped / Hvězdicové
Łożyska / Bearings / Ložiska	Igielkowe / Needle roller / Jehlová	Igielkowe / Needle roller / Jehlová	Igielkowe / Needle roller / Jehlová	Igielkowe / Needle roller / Jehlová	Igielkowe / Needle roller / Jehlová	-	-	-
Długość / Lenght / Délka	220 cm	220 cm	220 cm	201 cm	183 cm	120 cm	120 cm	120 cm / 150 cm / 180 cm / 200 cm
Maksymalne obciążenie / Maximum load / Maximální zatížení	700 kg	700 kg	450 kg	450 kg	320 kg	160 kg	160 kg	130 kg
Waga netto / brutto / Weight netto / brutto / Hmotnost produktu netto / brutto	20 / 20,5 kg	20 / 23 kg	18,5 / 19 kg	15 / 18 kg	16 / 16,3 kg	6,5 / 7 kg	6,75 / 7,2 kg	GO120: 7,9 / 8,2 kg / GO150: 12,9 / 13,2 kg / GO180: 14 / 14,3 kg / GO200: 16,2 / 16,5 kg
Wymiary opakowania / Packaging dimensions / Rozměry balení	225 x 6 x 6 cm	225 x 6 x 6 cm	225 x 6 x 6 cm	203 x 6 x 6 cm	186 x 6 x 6 cm	123 x 6 x 6 cm	123 x 6 x 6 cm	123 x 6 x 6 cm / 153 x 6 x 6 cm / 183 x 6 x 6 cm / 203 x 6 x 6 cm



WNK01



Neck protector

17-62-032



WNK02



Neck protector

17-62-037



FG01



Hand gripz

17-62-030



FR01



Hand gripz

17-62-031



ZG1500



Lock jaw collars

17-62-041 GOLD
17-62-040 SILVER



ZG1000



Lock jaw collars

17-62-038 RED
17-62-039 BLACK





GR50



Bar chain

17-62-115



GR30



Bar chain

17-62-113



GR10



Bar chain

17-62-110





HRX01



Weight lifting hook

17-62-024



ONX01



Wrist wraps

17-62-018



OPX01



Ankle straps

17-62-020



OKX01



Knee wraps

17-62-016





F4432



Lifting strap

17-62-026

HMS®



F4431

Lifting strap

17-62-027

HMS®



Model / Model / Třída	WNK01	WNK02	FG01	FR01	ZG 1500	ZG 1000
	Ochraniacz na kark / Neck protector / Chránič krku	Ochraniacz na kark / Neck protector / Chránič krku	Nakładki na gryf / Hand gripz / Překrytí na hmatníku	Nakładki na gryf / Hand gripz / Překrytí na hmatníku	Zaciski szczękowe / Lock jaw collars / Čelistové svorky	Zaciski szczękowe / Lock jaw collars / Čelistové svorky
Materiał / Material / Materiál	TPR	NBR	Silikon / Silicone / Silikon	Silikon / Silicone / Silikon	Aluminium / Aluminium / Hliník	Plastik / Plastic / Plast
Zestaw zawiera 2 szt. / Set includes 2 pcs. / Sada obsahuje 2 ks.	-	-	•	•	•	•
Kolory / Colors / Barvy	Szary / Gray / Šedá	Czarny / Black / Černá	Szary / Gray / Šedá	Szary / Gray / Šedá	Srebrny, Złoty / Silver, Gold / Stříbro, Zlato	Czerwony, Czarny / Red, Black / Červená, Černá
Długość / Length / Délka	320 mm	460 mm	127 mm	70 mm	-	-
Szerokość / Width / Šířka	140 mm	100 mm	55 mm	70 mm	38 mm	48 mm
Średnica wewnętrzna / Inner diameter / Vnitřní průměr	-	50 mm	29 mm	29 mm	50 mm	50 mm



Model / Model / Třída	GR50	GR30	GR10
	Łańcuch na gryf / Bar chain / Řetězy na hřidel	Łańcuch na gryf / Bar chain / Řetězy na hřidel	Łańcuch na gryf / Bar chain / Řetězy na hřidel
Zestaw zawiera 2 szt. / Set includes 2 pcs. / Sada obsahuje 2 ks.	•	•	•
Materiał / Material / Materiál	Stal / Steel / Ocel	Stal / Steel / Ocel	Stal / Steel / Ocel
Długość całkowita / Total length / Celková délka	157 cm	195 cm	180 cm
Szerokość/długość oczek Width/length Šířka/délka	9,5 / 14 cm	7 / 9 cm	3,5 / 4,5 cm
Średnica zacisków / Collars diameter / Průměr svorek	51 mm	51 mm	51 mm
Waga zestawu / Set weight / Sada závaží	50 kg	30 kg	10 kg

Model / Model / Třída	HRX01	ONX01	OPX01	OKX01	F4432	F4431
	Hak do martwego ciągu / Weight lifting hook / Kovový hák	Owijaki na nadgarstki / Wrist wraps / Zápěstí zábal	Opaski na kostkę / Ankle straps / Kotníkové pásy	Owijaki na kolana / Knee wraps / Kolenní zápěstí	Paski treningowe do martwego ciągu / Lifting strap / Zvedací popruhy	Paski treningowe do martwego ciągu / Lifting strap / Zvedací popruhy
Materiał / Material / Materiál	Stal, neopren, nylon / Steel, neoprene, nylon / Ocel, neopren, nylon	PC	Stal, neopren, nylon / Steel, neoprene, nylon / Ocel, neopren, nylon	PC	Nylon, neopren / Nylon, neoprene / Nylone, neoprene	Nylon, neopren / Nylon, neoprene / Nylone, neoprene
Zapięcie / Fastening / Zapínání	Elastyczny rzep / Velcro with elastic / Suchý zip s elastický povrchem	Elastyczny rzep / Velcro with elastic / Suchý zip s elastický povrchem	-	Elastyczny rzep / Velcro with elastic / Suchý zip s elastický povrchem	-	-
Długość / Length / Délka	43 cm	42 cm	26,5 cm	153,8 cm	58 cm	49 cm
Szerokość / Width / Šířka	8 cm	8 cm	10 cm	8 cm	3,8 cm	4 cm
Wysokość / Length / Výška	16,5 cm	-	-	-	-	-





TBR PROFI SET



Olympic plate - bumper set
17-61-000



CBR



Olympic plate - bumper

- 17-61-024 25 KG
- 17-61-023 20 KG
- 17-61-022 15 KG
- 17-61-021 10 KG
- 17-61-020 5 KG





- 17-61-029 25 KG
- 17-61-028 20 KG
- 17-61-027 15 KG
- 17-61-026 10 KG
- 17-61-025 5 KG

HTBR



Olympic plate - bumper



- 17-61-019 25 KG
- 17-61-018 20 KG
- 17-61-017 15 KG
- 17-61-016 10 KG
- 17-61-015 5 KG

BBR



Olympic plate - bumper



- 17-61-080 20 KG
- 17-61-079 15 KG
- 17-61-078 10 KG
- 17-61-077 5 KG
- 17-61-076 2,5 KG
- 17-61-075 1.25 KG

TGU



Olympic plate





- 17-61-036 20 KG
- 17-61-035 15 KG
- 17-61-034 10 KG
- 17-61-033 5 KG
- 17-61-032 2,5 KG
- 17-61-031 12,5 KG

TOK



Olympic plate



- 17-61-045 20 KG
- 17-61-044 15 KG
- 17-61-043 10 KG
- 17-61-042 5 KG
- 17-61-041 2,5 KG
- 17-61-040 12,5 KG

TOG



Olympic plate



- 17-61-054 20 KG
- 17-61-053 10 KG
- 17-61-052 5 KG
- 17-61-051 2,5 KG
- 17-61-050 12,5 KG

THM



Hammertone plate





Model / Model / Třída	TBR PROFI SET	CBR	HTBR	BBR	TGU	TOK	TOG	THM	
	Talerz olimpijski - bumper / Olympic plate - bumper / Olympijský kotouč - bumper	Talerz olimpijski - bumper / Olympic plate - bumper / Olympijský kotouč - bumper	Talerz olimpijski - bumper / Olympic plate - bumper / Olympijský kotouč - bumper	Talerz olimpijski - bumper / Olympic plate - bumper / Olympijský kotouč - bumper	Talerz olimpijski - bumper / Olympic plate - bumper / Olympijský kotouč - bumper	Talerz olimpijski / Olympic plate / Olympijský kotouč	Talerz olimpijski / Olympic plate / Olympijský kotouč	Talerz olimpijski / Olympic plate / Olympijský kotouč	Talerz hammertone / Hammertone plate / Kotouč hammertone
Materiál / Material / Materiál	NR, SBR	NR, SBR	Stal, guma / Steel, rubber / Ocel, guma	NR, SBR	Stal, guma / Steel, rubber / Ocel, guma	Želiwo pokryte gumą / Cast iron covered with rubber / Litiny potažené pryží	Želiwo pokryte gumą / Cast iron covered with rubber / Litiny potažené pryží	Želiwo / Cast iron / Litina	
Wagi / Weight / Hmotnost	5 kg, 10 kg, 15 kg, 20 kg, 25 kg	5 kg, 10 kg, 15 kg, 20 kg, 25 kg	5 kg, 10 kg, 15 kg, 20 kg, 25 kg	5 kg, 10 kg, 15 kg, 20 kg, 25 kg	1,25 kg, 2,5 kg, 5 kg, 10 kg, 15 kg, 20 kg	1,25 kg, 2,5 kg, 5 kg, 10 kg, 15 kg, 20 kg	1,25 kg, 2,5 kg, 5 kg, 10 kg, 15 kg, 20 kg	1,25 kg, 2,5 kg, 5 kg, 10 kg, 20 kg	
Średnica wewnętrzna / Inner diameter / Vnitřní průměr	51 mm	51 mm	51 mm	51 mm	51 mm	51 mm	51 mm	31 mm	
Średnica zewnętrzna / Outer diameter / Vnější průměr	340 mm / 450 mm / 450 mm / 450 mm / 450 mm	450 mm	450 mm	450 mm	208 mm / 275 mm / 447 mm / 447 mm / 447 mm / 447 mm	175 mm / 200 mm / 240 mm / 320 mm / 350 mm / 400 mm	180 mm / 200 mm / 245 mm / 290 mm / 360 mm / 420 mm	165 mm / 190 mm / 240 mm / 335 mm / 410 mm	
Grubość / Thickness / Tloušťka	25 mm / 36 mm / 47 mm / 55 mm / 65 mm	26 mm / 46 mm / 63 mm / 72 mm / 84 mm	34 mm / 60 mm / 78 mm / 88 mm / 100 mm	26 mm / 46 mm / 63 mm / 72 mm / 84 mm	30 mm / 34 mm / 25 mm / 39 mm / 27mm	28 mm / 35 mm / 42 mm / 47 mm / 45 mm / 45 mm	28 mm / 30 mm / 32 mm / 45 mm / 40 mm / 40 mm	14 mm / 21 mm / 26 mm / 30 mm / 35 mm	
Ilość w opakowaniu zbiorczym / Multipacking / Počet w veľkoobchodního balení	10 pcs (150 kg)	2 / 2 / 1 / 1 / 1	2 / 2 / 1 / 1 / 1	2 / 2 / 1 / 1 / 1	8 / 8 / 2 / 2 / 1 / 1	16 / 8 / 4 / 2 / 1 / 1	16 / 8 / 4 / 2 / 1 / 1	16 / 8 / 4 / 2 / 1	
Waga opakowania zbiorczego / Multipack weight / Hmotnost veľkoobchodního balení	165 kg	10 kg / 20 kg / 15 kg / 20 kg / 25 kg	10 kg / 20 kg / 15 kg / 20 kg / 25 kg	10 kg / 20 kg / 15 kg / 20 kg / 25 kg	11 kg / 21 kg / 11 kg / 21 kg / 16 kg / 21 kg	20,5 kg / 21 kg / 20,5 kg / 20,5 kg / 5,5 kg / 20,5kg	21 kg	21 kg / 8 kg / 20 kg / 21 kg / 20 kg	



ST20



Dumbbell set in suitcase
17-59-101



SJC20



Dumbbell set in suitcase
17-59-105



SJC15



Dumbbell set in suitcase
17-59-110





SG04



Threaded dumbbell

17-59-120



SG03



Threaded dumbbell

17-59-121



SG01



Threaded dumbbell

17-59-123





Model / Model / Třída	ST20	SJC20	SJC15
	Szangielka w walizce / Dumbbell set in suitcase / Činky v kufříku - kotouče	Szangielka w walizce / Dumbbell set in suitcase / Činky v kufříku - kotouče	Szangielka w walizce / Dumbbell set in suitcase / Činky v kufříku - kotouče
Zestaw zawiera / Set includes / Součástí soupravy jsou	Gryf (2 szt.), talerze (8 szt.), zaciski (4 szt.) / Grip (2 pcs.), plates (8 pcs.), collars (4 pcs.) / Hřídel (2 ks.), kotoučů (8 ks.), matice (4 ks.)	Gryf (2 szt.), talerze (4 szt.), zaciski (4 szt.) / Grip (2 pcs.), plates (4 pcs.), collars (4 pcs.) / Hřídel (2 ks.), kotoučů (4 ks.), matice (4 ks.)	Gryf (2 szt.), talerze (12 szt.), zaciski (4 szt.) / Grip (2 pcs.), plates (12 pcs.), collars (4 pcs.) / Hřídel (2 ks.), kotoučů (12 ks.), matice (4 ks.)
Materiał / Material / Materiál	Stal niklowana / Nickled-plated steel / Niklovaná ocel	Stal niklowana / Nickled-plated steel / Niklovaná ocel	Stal chromowana / Chrome steel / Chromovaná ocel
Talerze / Plates / Kotouče	4 x 1,25 kg / 4 x 2,25 kg	4 x 0,75 kg / 4 x 1,5 kg / 4 x 2 kg	4 x 0,5 kg / 8 x 1,25 kg
Długość gryfu / Bar length / Délka hřídel	35 cm	35 cm	35 cm
Średnica gryfu / Bar diameter / Průměr hřídel	30 mm	30 mm	30 mm
Zaciski (2 szt.) / Collar (2 pcs.) / Matice (2 ks.)	Gwiazdowe / Star shaped / Mvězdicové	Gwiazdowe / Star shaped / Mvězdicové	Gwiazdowe / Star shaped / Mvězdicové

Model / Model / Třída	SG04	SG03	SG01
	Sztangielka z gwintem / Threaded dumbbell / Jednoruční činka	Sztangielka z gwintem / Threaded dumbbell / Jednoruční činka	Sztangielka z gwintem / Threaded dumbbell / Jednoruční činka
Materiał / Material / Materiál	Stal niklowana / Nickled-plated steel / Niklovaná ocel	Stal niklowana / Nickled-plated steel / Niklovaná ocel	Stal niklowana / Nickled-plated steel / Niklovaná ocel
Talerze / Plates / Kotouče	2 x 1,25 kg / 4 x 1,5 kg / 2 x 2 kg	2 x 0,5 kg / 2 x 1 kg / 2 x 2,25 kg	2 x 1 kg / 2 x 1,25 kg
Długość gryfu / Bar length / Délka hřídel	35 cm	35 cm	35 cm
Średnica gryfu / Bar diameter / Průměr hřídel	30 mm	30 mm	30 mm
Zaciski (2 szt.) / Collar (2 pcs.) / Matice (2 ks.)	Gwiazdowe / Star shaped / Mvězdicové	Gwiazdowe / Star shaped / Mvězdicové	Gwiazdowe / Star shaped / Mvězdicové
Waga netto / brutto / Weight netto / brutto / Hmotnost produktu netto / brutto	15 / 15,5 kg	10 / 10,5 kg	7 / 7,5 kg
Wymiary opakowania / Packaging dimensions / Rozměry balení	38,5 x 17 x 9,5 cm	38 x 17 x 7,5 cm	37 x 17,5 x 5,5 cm



SR80



Adjustable dumbbell

17-59-151





SR52



Adjustable dumbbell

17-59-150



Model / Model / Třída	SR52	SR80
	Sztangielka regulowana / Adjustable dumbbell / Nastavitelná hřídel	Sztangielka regulowana / Adjustable dumbbell / Nastavitelná hřídel
	Zestaw zawiera: gryf, talerze (10 szt.), podstawkę / Set includes: grip, plates (10 pcs), holder / Součástí setu je hřídel, kotouče (10 ks) a podstavec	Zestaw zawiera: gryf, talerze (10 szt.), podstawkę / Set includes: grip, plates (10 pcs), holder / Součástí setu je hřídel, kotouče (10 ks) a podstavec
Material/ Material/ Materiál	Stal, guma, PP / Steel, rubber, PP / Ocel, guma, PP	Stal, PP / Steel, PP / Ocel, PP
Zakres regulacji obciążenia / Load adjustment range / Rozsah regulace zátěže	2,2 - 23,8 kg	5 - 36 kg
Talerze / Plates / Kotouče	2 x 0,6 kg / 2 x 1,15 kg / 2 x 2,2 kg / 4 x 3,3 kg	2 x 1 kg / 2 x 2,15 kg / 2 x 3,00 kg / 2 x 4,3 kg / 2 x 6,4 kg
Średnica talerzy / Plates diameter / Průměr kotoučů	16,5 - 21 cm	17 - 24 kg
Długość gryfu / Grip length / Délka činka	42 cm	45,5 cm
Wymiary podstawki / Support dimensions / Rozměry podstavce	43,5 x 22,5 x 8,5 cm	43 x 24 x 11,5 cm
Waga netto, brutto/ Weight netto, brutto / Hmotnost produktu netto, brutto	25,5 / 26,5 kg	42,2 / 43,5 kg
Wymiary opakowania / Packing dimensions / Rozměry balení	56 x 35,5 x 30 cm	66 x 43 x 43 cm





Hex Pro



Dumbbell

17-66-133 60 KG	17-66-121 25 KG
17-66-132 55 KG	17-66-120 22,5 KG
17-66-131 50 KG	17-66-119 20 KG
17-66-130 47,5 KG	17-66-118 18 KG
17-66-129 45 KG	17-66-117 16 KG
17-66-128 42,5 KG	17-66-116 14 KG
17-66-127 40 KG	17-66-115 12 KG
17-66-126 37,5 KG	17-66-114 10 KG
17-66-125 35 KG	17-66-113 8 KG
17-66-124 32,5 KG	17-66-112 6 KG
17-66-123 30 KG	17-66-111 4 KG
17-66-122 27,5 KG	17-66-110 2 KG



Model / Model / Třída	Hex Pro
	Hantla / Dumbbell / Činka
Materiał / Material / Materiál	Stal, guma / Steel, rubber / Ocel, guma
Uchwyt / Grip / Rukojet	Radelkowany / Knurled / Vroubkovaná
Dostępne wagi / Available weight / K dispozici hmotnost	2 / 4 / 6 / 8 / 10 / 12 / 14 / 16 / 18 / 20 / 22,5 / 25 / 27,5 / 30 / 32,5 / 35 / 37,5 / 40 / 42,5 / 45 / 47,5 / 50 / 55 / 60 kg
Długość hantli / Dumbbell weight / Délka činka	251 / 277 / 304 / 308 / 322 / 333 / 334 / 340 / 350 / 365 / 373 / 375 / 380 / 390 / 391 / 401 / 411 / 417 / 420 / 430 / 436 / 443 / 453 / 457 mm
Średnica części chwytnej / Diameter of the grip / Průměr rukojeti	2 kg, 4 kg = 27 mm 6 kg - 60 kg = 34 mm
Długość części chwytnej / Length of the grip / Délka rukojeti	110 mm
Wymiary opakowania zbiorczoego / Multipack dimensions / Rozměry velkoobchodního balení	38 x 26 x 15 / 28 x 22 x 18 / 31 x 24 x 11 / 36 x 22 x 13 / 33 x 28 x 14 / 35 x 17 x 15 / 35 x 15 x 16 / 37 x 15 x 17 / 37 x 15 x 18 / 38 x 16 x 18 / 38 x 17 x 18 / 38 x 17 x 18 / 40 x 17 x 18 / 40 x 17 x 18 / 40 x 17 x 18 / 40 x 17 x 18 / 40 x 21 x 20 / 43 x 20 x 13 / 43 x 20 x 13 / 44 x 23 x 18 / 44 x 23 x 18 / 45 x 23 x 20 / 45 x 23 x 20 / 47 x 24 x 21 cm



KR40



Adjustable kettlebell

17-64-800



KRM20



Adjustable kettlebell

17-64-810



KGC



Cast iron kettlebell

- 17-64-057 24 KG
- 17-64-056 20 KG
- 17-64-055 16 KG
- 17-64-054 12 KG
- 17-64-053 10 KG
- 17-64-052 8 KG
- 17-64-051 6 KG
- 17-64-050 4 KG





KZG



Cast iron kettlebell

17-64-018 32 KG
 17-64-017 28 KG
 17-64-016 24 KG
 17-64-015 20 KG
 17-64-014 16 KG
 17-64-013 12 KG
 17-64-012 8 KG
 17-64-011 6 KG
 17-64-010 4 KG



KTC



Cast iron kettlebell

17-64-076 BLACK 20 KG
 17-64-075 BLACK 16 KG
 17-64-074 BLACK 12 KG
 17-64-073 RED 10 KG
 17-64-072 RED 8 KG
 17-64-071 RED 6 KG
 17-64-070 RED 4 KG



KNV



Cast iron kettlebell

17-64-048 BLUE 32 KG
 17-64-047 BLUE 28 KG
 17-64-046 BLUE 24 KG
 17-64-045 BLUE 20 KG
 17-64-044 BLUE 16 KG
 17-64-043 BLUE 12 KG
 17-64-042 BLUE 8 KG
 17-64-041 BLUE 6 KG
 17-64-040 BLUE 4 KG

17-64-068 BLACK 32 KG
 17-64-067 BLACK 28 KG
 17-64-066 BLACK 24 KG
 17-64-065 BLACK 20 KG
 17-64-064 BLACK 16 KG
 17-64-063 BLACK 12 KG
 17-64-062 BLACK 8 KG
 17-64-061 BLACK 6 KG
 17-64-060 BLACK 4 KG





Model / Model / Třída	KR40	KRM20
	Kettlebell regulowany / Adjustable kettlebell / Nastavitelný kettlebell	Kettlebell regulowany miękki / Adjustable soft kettlebell / Měkký kettlebell
Materiał / Material / Materiál	Stal, ABS / Steel, ABS / Ocel, ABS	Neopren / Neoprene / Neopren
Zakres regulacji obciążenia / Load adjustment range / Rozsah regulace zátěže	3,45 - 17,1 kg	0,6 - 8,75 kg
Talerze / Plates / Kotouče	6 x 2,2 kg	2 x 1,4 / 2 x 6 kg
Wysokość / Hight / Výška	27 cm	30 cm
Średnica talerzy / Diameter of plates / Průměr kotoučů	-	20 / 25 cm
Średnica części kulistej / Diameter of spherical part / Průměr kulové části	20 cm	-
Szerokość uchwytu / Handle width / Šířka úchopu	22,5 cm	-
Średnica uchwytu / Handle diameter / Průměr úchopu	30 mm	-
Waga netto / brutto / Weight netto / brutto / Hmotnost produktu netto / brutto	18 / 18,585 kg	9 / 9,5 kg
Wymiary opakowania / Packaging dimensions / Rozměry balení	25,7 x 22,3 x 32,5 cm	23 x 23 x 20 cm

Model / Model / Třída	KGC	KZG	KTC	KNV
	Kettlebell żeliwny / Cast iron kettlebell / Železo kettlebell	Kettlebell żeliwny / Cast iron kettlebell / Železo kettlebell	Kettlebell żeliwny / Cast iron kettlebell / Železo kettlebell	Kettlebell żeliwny / Cast iron kettlebell / Železo kettlebell
Materiał / Material / Materiál	Żeliwo pokryte gumą / Cast iron covered with rubber / Litiny potažené pryží	Żeliwo pokryte gumą / Cast iron covered with rubber / Litiny potažené pryží	Żeliwo pokryte winylem / Cast iron covered with vinyl / litiny pokryt vinylem	Żeliwo pokryte winylem / Cast iron covered with vinyl / litiny pokryt vinylem
Uchwyt / Grip / Rukojeti	Chromowane / Chrome plated / Chromovaný	-	Chromowane / Chrome plated / Chromovaný	-
Dostępne wagi / Available weight / K dispozici hmotnost	4 kg / 6 kg / 8 kg / 10 kg / 12 kg / 16 kg / 20 kg / 24 kg	4 kg / 6 kg / 8 kg / 10 kg / 12 kg / 16 kg / 20 kg / 24 kg / 28 kg / 32 kg	4 kg / 6 kg / 8 kg / 10 kg / 12 kg / 16 kg / 20 kg	4 kg / 6 kg / 8 kg / 10 kg / 12 kg / 16 kg / 20 kg / 24 kg / 28 kg / 32 kg
Ilość w opakowaniu zbiorczym / Multipacking / Počet w velkoobchodního balení	6 / 4 / 2 / 2 / 2 / 1 / 1 / 1	1	4 / 3 / 2 / 2 / 1 / 1 / 1	6 / 4 / 2 / 1 / 1 / 1 / 1 / 1
Waga opakowania / Weight of package / Hmotnost balení	25 / 25 / 16,5 / 20,5 / 24,5 / 16,5 / 20,5 / 24,5 kg	4,5 / 6,5 / 8,5 / 10,5 / 12,5 / 16,5 / 20,5 / 24,5 / 28,5 / 32,5 kg	16,5 / 18,5 / 16,5 / 20,5 / 12,5 / 16,5 / 20,5 kg	25 / 25 / 16,5 / 12,5 / 16,5 / 20,5 / 24,5 / 28,5 / 32,5 kg



HH 01/02/03/04/05/06/07/08/09/10



Dumbbell

- 17-66-143 10 KG
- 17-66-142 9 KG
- 17-66-141 8 KG
- 17-66-140 7 KG
- 17-66-139 6 KG
- 17-66-138 5 KG
- 17-66-137 4 KG
- 17-66-136 3 KG
- 17-66-135 2 KG
- 17-66-134 1 KG



CK 05/10/15/20



Cast iron dumbbell

- 17-47-123 20 KG
- 17-47-122 15 KG
- 17-47-121 10 KG
- 17-47-120 5 KG



17023



Cast iron dumbbell

- 17-47-007 5 KG
- 17-47-006 4 KG
- 17-47-005 3 KG
- 17-47-004 2 KG
- 17-47-003 1,5 KG
- 17-47-002 1 KG
- 17-47-001 0,75 KG
- 17-47-000 0,5 KG



- 17-47-114 2 KG
- 17-47-113 1,5 KG
- 17-47-112 1 KG
- 17-47-111 0,75 KG
- 17-47-110 0,5 KG

17025



Cast iron dumbbell



- 17-47-210 CM04 2 x 1 KG
- 17-47-211 CM05 2 x 1,5 KG

CM04 / CM05



Soft dumbbells



- 17-47-310 OB02 BLUE 2 x 0.7 KG
- 17-47-310 OB02 RED 2 x 0.7 KG
- 17-47-313 OB02 BLUE 2 x 1,5 KG
- 17-47-314 OB02 RED 2 x 1,5 KG

OB02 / OB03



Pillow weights





Model / Model / Třída	HH01 / 02 / 03 / 04 / 05 / 06 / 07 / 08 / 09 / 10
	Hantla / Dumbbell / Činka
Materiał / Material / Materiál	Chromowana stal, silikon / Chromed steel, silicone / Pochromovaná ocel, silikon
Uchwyt / Grip / Rukojet	Radelkowany / Knurled / Vroubkovaná
Dostępne wagi / Available weight / K dispozici hmotnost	1 / 2 / 3 / 4 / 5 / 6 / 7 / 8 / 9 / 10 kg
Długość hantli / Dumbbell weight / Délka činka	187,8 / 219 / 251 / 267 / 280 / 298 / 302 / 304 / 310,4 / 308,4 mm
Średnica części chwytnej / Diameter of the grip / Průměr rukojeti	32 mm
Długość części chwytnej / Length of the grip / Délka rukojeti	145 / 155 / 155 / 155 / 155 / 162 / 162 / 162 / 162 / 162 mm
Wymiary opakowania zbiorczego / Multipack dimensions / Rozměry velkoobchodního balení	17 x 8,6 x 4,3 cm 19 x 12,6 x 6,3 cm 21,6 x 13 x 6,5 cm 23,5 x 14 x 7 cm 25 x 15,5 x 8 cm 26 x 16,5 x 8 cm 26,5 x 17,5 x 9 cm 27 x 18,5 x 9 cm 27 x 19,5 x 10 cm 27 x 21 x 10,5 cm
Ilość w opakowaniu zbiorczym / Multipacking / Počet w velkoobchodního balení	2
Waga opakowania zbiorczego / Multipack weight / Hmotnost velkoobchodního balení	2 / 4 / 6 / 8 / 10 / 12 / 14 / 16 / 18 / 20 kg

Model / Model / Třída	17023	17025	CK05 / 10/ 15/ 20	CM04 / CM05	OB02 / OB03
	Cieżarek żeliwny / Cast iron dumbbell / Litinová činka	Cieżarek żeliwny / Cast iron dumbbell / Litinová činka	Cieżarek żeliwny / Cast iron dumbbell / Litinová činka	Cieżarki miękkie / Soft dumbbells / Měkké činky	Obciążniki na ręce i nogi / Pillow weights / Závaží na ruce a nohy
Materiał / Material / Materiál	Żeliwo pokryte winylem / Cast iron vinyl dipping / Litina pokrytá vinylem	Żeliwo pokryte neoprenem / Cast iron neoprene dipping / Litina pokrytá neoprenem	Żeliwo pokryte neoprenem / Cast iron neoprene dipping / Litina pokrytá neoprenem	Żeliwo, pianka o dużej gęstości / Cast iron, high thickness foam / Latina, pěnovka vysoké hustoty	Miękkie poszycie wypełnione metalowym srutem / Soft sheathin filled with metal grit / Měkká látka vyplněná železnými pilinami
Dostępne wagi / Available weight / K dispozici hmotnost	0,5 / 0,75 / 1 / 1,5 / 2 / 3 / 4 / 5 kg	0,5 / 0,75 / 1 / 1,5 / 2 kg	0,5 / 1 / 1,5 / 2 kg	CM04: 2 x 1 kg CM05: 2 x 1,5 kg	OB02: 2 x 0,7 kg OB03: 2 x 1,5 kg
Zapięcie / Fastening / Zapínání	-	-	-	-	Pasek na rzep / Velcro strap / Suchý zip
Waga netto / brutto / Weight netto / brutto / Hmotnost produktu netto / brutto	0,5 / 0,75 / 1 / 1,5 / 2 / 3 / 4 / 5 kg	0,5 / 0,75 / 1 / 1,5 / 2 kg	0,5 / 1 / 1,5 / 2 kg	CM04: 2 / 2,125 kg CM05: 3 / 3,333 kg	OB02: 1,4 / 1,5 kg OB03: 3 / 3,166 kg
Wymiary opakowania / Packaging dimensions / Rozměry balení	-	-	-	CM04: 23 x 10 x 5 cm CM05: 24 x 12,5 x 5,5 cm	OB02: 22 x 10 x 5 cm OB03: 24 x 12 x 6 cm
Ilość w opakowaniu zbiorczym / Multipacking / Počet w velkoobchodního balení	40 / 20 / 20 / 12 / 10 / 6 / 4 / 4	40 / 20 / 20 / 12 / 10	30 / 20 / 12 / 8	CM04: 8 CM05: 6	OB02: 10 OB03: 6
Wymiary opakowania zbiorczego / Multipack dimensions / Rozměry velkoobchodního balení	29 x 24 x 19 cm 32 x 32 x 13 cm 32 x 31 x 13 cm 33 x 20 x 13,5 cm 37,5 x 19 x 14,5 cm 26,5 x 20 x 18 cm 29,5 x 21 x 19 cm 21 x 20 x 18 cm	15 x 4,5 x 4,5 cm 15 x 4,5 x 4,5 cm 35 x 25 x 10 cm 40 x 20 x 11 cm 30,5 x 21,5 x 12,5 cm	23 x 23 x 12,5 cm 26 x 17,5 x 16 cm 28,5 x 20,5 x 13 cm 31 x 21 x 8 cm	CM04: 24 x 22 x 21 cm CM05: 25,5 x 26 x 2 cm	OB02: 24 x 27 x 21 cm OB03: 26 x 25 x 20 cm
Waga opakowania zbiorczego / Multipack weight / Hmotnost velkoobchodního balení	21 / 16 / 21 / 19 / 21 / 19 / 18 / 21 kg	21 / 16 / 21 / 19 / 21 kg	15,5 / 20,5 / 18,5 / 16,5 kg	CM04: 17 kg CM05: 20 kg	OB02: 15 kg OB03: 19 kg



PA3558



- 17-63-044 XXL
- 17-63-043 XL
- 17-63-042 L
- 17-63-041 M
- 17-63-040 S

Power belt



PA3778



- 17-63-034 XXL
- 17-63-033 XL
- 17-63-032 L
- 17-63-031 M
- 17-63-030 S

Gym belt



PST04



17-62-036

Dipping belt



PA3448



- GRAY
- 17-63-059 XXL
- 17-63-058 XL
- 17-63-057 L
- 17-63-056 M
- 17-63-055 S

Training belt

- BLACK
- 17-63-054 XXL
- 17-63-053 XL
- 17-63-052 L
- 17-63-051 M
- 17-63-050 S





RST01



Men's fitness gloves

- | | |
|---------------|---------------|
| BLACK/YELLOW | BLACK/RED |
| 17-63-204 XXL | 17-63-209 XXL |
| 17-63-203 XL | 17-63-208 XL |
| 17-63-202 L | 17-63-207 L |
| 17-63-201 M | 17-63-206 M |
| 17-63-200 s | 17-63-205 s |



RST02



Men's fitness gloves

- | | |
|---------------|---------------|
| BLACK/RED | BLACK/BLUE |
| 17-63-219 XXL | 17-63-214 XXL |
| 17-63-218 XL | 17-63-213 XL |
| 17-63-217 L | 17-63-212 L |
| 17-63-216 M | 17-63-211 M |
| 17-63-215 s | 17-63-210 s |



RST03



Women's fitness gloves

- | | |
|-------------|-------------|
| PINK/GRAY | ORANGE/GRAY |
| 17-63-222 L | 17-63-227 L |
| 17-63-221 M | 17-63-226 M |
| 17-63-220 s | 17-63-225 s |





Model / Model / Třída	PA3558	PA3778	PST04	PA3448
	Pas kulturystyczny / Power belt / Napájecího pásu	Pas do ćwiczeń / Gym belt / Télécvična	Pas obciążeniowy kulturystyczny / Dipping belt / Ponorný pás	Pas do ćwiczeń / Gym belt / Télécvična
Rozmiary / Sizes / Rozměry	S, M, L, XL, XXL	S, M, L, XL, XXL	Jeden rozmiar / One size / Jedné rozměry	S, M, L, XL, XXL
Materiał / Material / Materiál	3-warstwowa skóra, pianka / 3-layer leather, foam / 3vrstvá kůže, pěna	Skóra, pianka / Leather, foam / Kůže, pěna	Stal / Steel / Ocel	Neopren, tkanina, Mesh / Neoprene, webbing, Mesh / Neopren, materiál popruhu, Mesh
Długość / Length / Délka	107 / 116 / 129 / 138 / 147 cm	90 / 106 / 117 / 126 / 135,5	72 cm	88,5 / 98 / 108,5 / 113 / 118,5 cm
Szerokość / Width / Šířka	10 cm	10 cm	18 cm	18 cm
Grubość / Thickness / Tloušťka	12 mm	6 mm	6 mm	6 mm

Model / Model / Třída	RST01	RST02	RST03
	Męskie rękawiczki fitness / Men's fitness gloves / Pánské fitness rukovice	Męskie rękawiczki fitness / Men's fitness gloves / Pánské fitness rukovice	Damskie rękawiczki fitness / Women's fitness gloves / Ženy fitness rukovice
	Ochronny pasek na nadgarstek / Protective wrist strap / Ochranný pásek na zápěstí	Przewiewny pasek na nadgarstek / Air Mesh material long wrist strap / Airy pouyko na zápěstí	Elastyczny pasek na nadgarstek / Elastic wrist strap / Elastický krátký popruh
Rzep / Velcro / Zip	•	•	•
Kolory / Colors / Barvy	Czerwony, żółty / Red, yellow / Červená, žlutý	Czerowny, niebieski / Red, blue / Červená, modrý	Pomarańczowy, różowy / Orange, pink / Oranžový, růžový
Rozmiary / Sizes / Rozměry	S, M, L, XL, XXL	S, M, L, XL, XXL	S, M, L
Materiał / Material / Materiál	Skóra, Mesh, silikon / Leather, Mesh, silicon / Kůže, mesh silikon	Skóra, Mesh, silikon / Leather, Mesh, silicon / Kůže, mesh silikon	Skóra, Mesh, silikon, pianka / Leather, Mesh, silicon, foam / Kůže, mesh silikon, pěna



STR10



Adjustable dumbbell rack

17-62-053



STR03



Rack for accessories

17-62-046



STR02



Body pump set rack

17-62-045





STR16



Body pump set rack

17-62-059



STR05



Barbell rack

17-62-048



STR07



Dumbbell rack

17-62-050



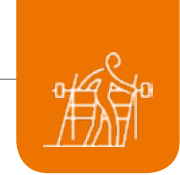

STR12



Dumbbell and barbell rack

17-62-055



STR09



Kettlebell rack

17-62-052



STR13



Olympic bar rack

17-62-056



STR15



Mat rack

17-62-058





STR06

Ball rack
17-62-049



STR14

Mat rack
17-62-057



STR11



Weight plate rack
17-62-054



STR17

Olympic bar rack
17-62-060





Model / Model / Třída	STR10	STR03	STR02	STR16	STR05	STR07	STR12
	Stojak na sztangi i regulowane / Adjustable dumbbell rack / Stojan pod variabilní činky	Stojak na akcesoria / Rack for accessories / Stojan pro příslušenství	Stojak do zestawu body pump / Body pump set rack / Stojan na bodu pump set	Stojak do body pump / Body pump set rack / Stojan na bodu pump set	Stojak na sztangi stale / Barbell rack / Stojan na činky	Stojak pionowy na hantle / Dumbbell rack / Vertikální stojan na cinky	Stojak na talerze i hantle / Dumbbell and barbell rack / Stojan na kotouče a hřídele
Materiál / Material / Materiál	Stal / Steel / Ocel	Stal / Steel / Ocel	Stal / Steel / Ocel	Stal / Steel / Ocel	Stal / Steel / Ocel	Stal / Steel / Ocel	Stal / Steel / Ocel
Wymiary produktu / Item size / Rozměry výrobku	70 x 68 x 68 cm	126 x 52 x 52 cm	145 x 55 x 130 cm	65 x 65 x 150 cm	90 x 70 x 125 cm	155 x 48 x 54 cm	100 x 45 x 102 cm
Wymiary opakowania / Packing dimensions / Rozměry balení	56,5 x 56 x 12,5 cm	123 x 52 x 23 cm	134 x 84 x 31,5 cm	150 x 35 x 15 cm	121 x 77 x 11 cm	158 x 57 x 8 cm	104 x 45 x 12 cm
Maksymalna waga obciążenia / Max load / Maximální zatížení	100 kg	300 kg	500 kg	200 kg	300 kg	200 kg	250 kg
Waga netto/brutto / Weight netto/brutto / Hmotnost produktu netto/ brutto	16/17 kg	18/20 kg	32/35 kg	30/31,8 kg	28/30 kg	17/18 kg	17/19 kg
Ilość w kontenerze 20'/40'/40HQ / Q-ty in container 20'/40'/40HQ / Množství v kontejneru 20'/40'/40HQ	709/1468/1722	189/392/459	79/163/192	356/738/865	272/563/660	389/806/944	491/1018/1193

Model / Model / Třída	STR09	STR13	STR15	STR06	STR14	STR11	STR17
	Stojak kettlebell / Kettlebell rack / Stojan na kettlebell	Stojak na gryfy olimpijskie / Barbell rack / Stojan na olympijská hřídele	Uchwyt na maty / Mat rack / Držák na podložky	Stojak na piłki / Ball rack / Stojan na míče	Stojak na maty / Mat rack / Stojan na podložky	Stojak na talerze / Weight plate rack / Stojan na kotouče	Stojak na sztange / Olympic bar rack / Stojan pod velkou činku
Materiál / Material / Materiál	Stal/ Steel/ Ocel	Stal/ Steel/ Ocel	Stal/ Steel/ Ocel	Stal/ Steel/ Ocel	Stal/ Steel/ Ocel	Stal/ Steel/ Ocel	Stal / Steel / Ocel
Wymiary produktu / Item size / Rozměry výrobku	150 x 56 x 80 cm	60 x 52 x 20 cm	60 x 25 x 2 cm	55 x 30 x 156 cm	190 x 60 x 60 cm	110 x 110 x 126 cm	110 x 20 x 15 cm
Wymiary opakowania / Packing dimensions / Rozměry balení	77 x 59 x 20 cm 154 x 29 x 10 cm"	62 x 25 x 28cm	62 x 10 x 10 cm	152 x 30 x 20 cm	118 x 20 x 10 cm	75 x 75 x 128 cm	100 x 25 x 27 cm
Maksymalna waga obciążenia / Max load / Maximální zatížení	300 kg	8 szt	40 kg	200 kg	40 kg	500 kg	400 kg
Waga netto/brutto / Weight netto/brutto / Hmotnost produktu netto/ brutto	48/53 kg	12/12,4 kg	8/8,3 kg	18/20 kg	18,5/19,3 kg	36/39 kg	106 - 170 cm
Ilość w kontenerze 20'/40'/40HQ / Q-ty in container 20'/40'/40HQ / Množství v kontejneru 20'/40'/40HQ	199/411/482	645/1336/1567	4516/9355/10968	304/630/739	1186/2458/2881	20/42/90	34/35,2 kg



TE1193



Arm sling

17-25-100



SZ1191



Cervical collar

17-25-150





KO1883



Knee support

- 17-24-011 XL
- 17-24-010 L
- 17-24-009 M
- 17-24-008 S



KO1785



Knee support

17-24-870



KO1525



Knee support

17-24-873



KO1879



Knee support

17-24-872





KO1822



Knee strap

17-24-871



SS1842



Ankle support

17-24-051 XL
17-24-050 L
17-24-049 M
17-24-048 S



SS1883



Ankle support

17-24-015 XL
17-24-014 L
17-24-013 M
17-24-012 S



SS1821



Ankle support

17-24-035 XL
17-24-034 L
17-24-033 M
17-24-032 S



SS1872



Ankle support

17-24-920





BR1869



Waist support

17-24-970



BR1313



Waist support

17-24-971



BR163



Waist support

17-24-973



BR114



Waist support

17-24-972





LO1883



Elbow support

- 17-24-007 XL
- 17-24-006 L
- 17-24-005 M
- 17-24-004 S



NA1248



Wrist support

17-24-800



NA1567



Wrist support

17-24-801



LO1821



Elbow support

- 17-24-027 XL
- 17-24-026 L
- 17-24-025 M
- 17-24-024 S



NA1420



Wrist support

17-24-802

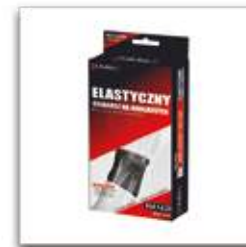

NA125



Wrist support

17-24-803





Model / Model / Třída	TE1193	SZ1191	KO1883	KO1785	KO1525	KO1879	KO1822	SS1842	SS1883	SS1821	SS1872
	Temblak uniwersalny / Arm sling / Univerzální popruh	Kolnier ortopedyczny / Cervical collar / Ortopedický límec	Stabilizator kolana / Knee support / Kolenní stabilizátor	Stabilizator stawu kolanowego / Knee support / Stabilizátor kolenního kloubu	Stabilizator kolana / Knee support / Kolenní stabilizátor	Stabilizator kolana / Knee support / Kolenní stabilizátor	Opaska pod kolano / Knee strap / Pásek pod koleno	Ściągacz na staw skokowy / Ankle support / Bandáž kotníku	Ściągacz na staw skokowy / Ankle support / Bandáž kotníku	Ściągacz na staw skokowy / Ankle support / Bandáž na kotník	Ściągacz na staw skokowy / Ankle support / Bandáž na kotník
Materiał / Material / Materiál	Neopren, EVA / Neoprene, EVA / Neopren, EVA	Pianka, poliester / Foam, polyester / Pěna, polyester	Neopren / Neoprene / Neopren	Neopren / Neoprene / Neopren	Nylon, spandex	Neopren / Neoprene / Neopren	Neopren, nylon / Neoprene, nylon / Neopren, nylon	Nylon, spandex, latex	Neopren / Neoprene / Neopren	Poliester / Polyester / Poliester	Dzianina / Knitwear / Pletený neoprenový materiál
Rozmiary / Sizes / Rozměry	Uniwersalny / One size / Univerzální	Uniwersalny / One size / Univerzální	S, M, L, XL	Uniwersalny / One size / Univerzální	Uniwersalny / One size / Univerzální	Uniwersalny / One size / Univerzální	Uniwersalny / One size / Univerzální	S, M, L, XL	S, M, L, XL	S, M, L, XL	Uniwersalny / One size / Univerzální
Długość / Length / Délka	20 cm	79 cm	27 / 28 / 28 / 28,5 cm	31,5 cm	27 cm	24 cm	40 cm	21 / 22 / 23 / 23,5 cm	20 / 21 / 22 / 22 cm	23 / 23,5 / 24 / 24 cm	16 cm
Szerokość / Width / Šířka	41 cm	10 cm	16 / 17 / 17,5 / 18 cm	18,5 cm	17 cm	17 cm	4 cm	11,5 / 12,5 / 12,5 / 13 cm	10,5 / 11,5 / 12,5 / 13 cm	9 / 10 / 11 / 11,5 cm	14 cm
Regulacja paska / Belt adjustment / Délka bandáže	•	-	-	•	-	-	-	-	-	-	-
Ilość w opakowaniu zbiorczym / Multipacking / Počet w veľkoobchodniho balení	20	24	160	40	160	72	160	160	160	160	160
Wymiary opakowania zbiorczego / Multipack dimensions / Rozměry veľkoobchodniho balení	46 x 29 x 40 kg	54 x 44 x 41cm	53 x 44 x 46 cm	53 x 44 x 46 cm	53 x 44 x 46 cm	53 x 44 x 46 cm	53 x 44 x 46 cm	57 x 37,5 x 40 cm	57 x 37,5 x 40 cm	57 x 37,5 x 40 cm	57 x 37,5 x 40 cm
Waga opakowania zbiorczego / Multipack weight / Hmotnosť veľkoobchodniho balení	7 kg	7 kg	10,3 kg	15 kg	17 kg	14 kg	14,8 kg	11,5 kg	10,5/ 11,5 kg	13/ 15 kg	12 kg

Model / Model / Třída	BR1869	BR1313	BR163	BR114	LO1883	LO1821	NA1248	NA1567	NA1420	NA125
	Ściągacz na brzuch / Waist support / Břišní bandáž	Ściągacz na brzuch / Waist support / Břišní bandáž	Ściągacz na brzuch / Waist support / Břišní bandáž	Ściągacz na brzuch / Waist support / Břišní bandáž	Ściągacz na łokieć / Elbow support / Bandáž lokte	Ściągacz na łokieć / Elbow support / Bandáž lokte	Ściągacz na nadgarstek / Wrist support / Bandáž zápěstí	Ściągacz na nadgarstek / Wrist support / Bandáž zápěstí	Ściągacz na nadgarstek / Wrist support / Bandáž zápěstí	Ściągacz na nadgarstek / Wrist support / Bandáž zápěstí
Materiał / Material / Materiál	Bawełna, elastan / Cotton, elastane / Bavlna, elastan	Neopren / Neoprene / Neopren	Neopren, nylon / Neoprene, nylon / Neopren, nylon	Neopren, nylon / Neoprene, nylon / Neopren, nylon	Neopren, EVA / Neoprene, EVA / Neopren, EVA	Neopren, EVA / Neoprene, EVA / Neopren, EVA	Neopren, EVA / Neoprene, EVA / Neopren, EVA	Neopren, EVA / Neoprene, EVA / Neopren, EVA	Neopren, EVA / Neoprene, EVA / Neopren, EVA	Neopren / Neoprene / Neopren
Rozmiary / Sizes / Rozměry	Uniwersalny / One size / Univerzální	Uniwersalny / One size / Univerzální	Uniwersalny / One size / Univerzální	Uniwersalny / One size / Univerzální	S, M, L, XL	S, M, L, XL	Uniwersalny / One size / Univerzální	Uniwersalny / One size / Univerzální	Uniwersalny / One size / Univerzální	Uniwersalny / One size / Univerzální
Długość / Length / Délka	112 cm	100 cm	100 cm	128 cm	21 / 22 / 23 / 23,5 cm	21 / 22 / 23 / 23,5 cm	37 cm	7 cm	7,5 cm	22 cm
Szerokość / Width / Šířka	17 cm	25 cm	19 cm	25 cm	11,5 / 12,5 / 12,5 / 13 cm	11,5 / 12,5 / 12,5 / 13 cm	11 cm	9 cm	33 cm	7,5 cm
Ilość w opakowaniu zbiorczym / Multipacking / Počet w veľkoobchodniho balení	36	72	40	40	20	20	20	20	20	50
Wymiary opakowania zbiorczego / Multipack dimensions / Rozměry veľkoobchodniho balení	57 x 37,5 x 40 cm	57 x 37,5 x 40 cm	46 x 29 x 37 cm	46 x 29 x 40 cm	57 x 37,5 x 40 cm	57 x 37,5 x 40 cm	57 x 37,5 x 40 cm	57 x 37,5 x 40 cm	57 x 37,5 x 40 cm	46 x 29 x 37 cm
Waga opakowania zbiorczego / Multipack weight / Hmotnosť veľkoobchodniho balení	12 kg	12 kg	9 kg	8 kg	12 / 13 kg	12 / 15 kg	11 kg	10 kg	10 kg	3,5 kg



ABISAL Sp. z o.o.
ul. Św. Elżbiety 6, 41-905 Bytom, Polska, tel. +48 32 388 60 60, fax +48 32 388 60 70
www.abisal.pl, www.hms-fitness.pl, e-mail: abisal@abisal.pl

ABISTORE SPORT S.R.O.
Poděbradova 111, 702 00 Ostrava, Česká republika, tel. +420 59 611 00 90, fax +420 59 513 69 00
www.abistore.cz, www.hms-fitness.pl, e-mail: abistore@abistore.cz